

A-SDR410E-160A

4-Channel Digital Video Recorder



WARNING

**RISK OF ELECTRIC SHOCK
DO NOT OPEN**



WARNING: TO REDUCE THE RISK OF ELECTRIC SHOCK,
DO NOT REMOVE COVER (OR BACK).
NO USER-SERVICEABLE PARTS INSIDE.
REFER SERVICING TO QUALIFIED
SERVICE PERSONNEL.



The lightning flash with arrowhead symbol, within an equilateral triangle, is intended to alert the user to the presence of uninsulated "dangerous voltage" within the product's enclosure that may be of sufficient magnitude to constitute a risk of electric shock.



The exclamation point within an equilateral triangle is intended to alert the user to the presence of important operating and maintenance (servicing) instructions in the literature accompanying the appliance.

COMPLIANCE NOTICE OF FCC:

THIS EQUIPMENT HAS BEEN TESTED AND FOUND TO COMPLY WITH THE LIMITS FOR A CLASS A DIGITAL DEVICE, PURSUANT TO PART 15 OF THE FCC RULES. THESE LIMITS ARE DESIGNED TO PROVIDE REASONABLE PROTECTION AGAINST HARMFUL INTERFERENCE WHEN THE EQUIPMENT IS OPERATED IN A COMMERCIAL ENVIRONMENT. THIS EQUIPMENT GENERATES, USES, AND CAN RADIATE RADIO FREQUENCY ENERGY AND IF NOT INSTALLED AND USED IN ACCORDANCE WITH THE INSTRUCTION MANUAL, MAY CAUSE HARMFUL INTERFERENCE TO RADIO COMMUNICATIONS. OPERATION OF THIS EQUIPMENT IN A RESIDENTIAL AREA IS LIKELY TO CAUSE HARMFUL INTERFERENCE, IN WHICH CASE USERS WILL BE REQUIRED TO CORRECT THE INTERFERENCE AT THEIR OWN EXPENSE.

WARNING: CHANGES OR MODIFICATIONS NOT EXPRESSLY APPROVED BY THE PARTY RESPONSIBLE FOR COMPLIANCE COULD VOID THE USER'S AUTHORITY TO OPERATE THE EQUIPMENT.

THIS CLASS OF DIGITAL APPARATUS MEETS ALL REQUIREMENTS OF THE CANADIAN INTERFERENCE-CAUSING EQUIPMENT REGULATIONS.

The information in this manual is believed to be accurate as of the date of publication. IDIS, Co., Ltd. is not responsible for any problems resulting from the use thereof. The information contained herein is subject to change without notice. Revisions or new editions to this publication may be issued to incorporate such changes.

Important Safeguards

1. Read Instructions

All the safety and operating instructions should be read before the appliance is operated.

2. Retain Instructions

The safety and operating instructions should be retained for future reference.

3. Cleaning

Unplug this equipment from the wall outlet before cleaning it. Do not use liquid aerosol cleaners. Use a damp soft cloth for cleaning.

4. Attachments

Never add any attachments and/or equipment without the approval of the manufacturer as such additions may result in the risk of fire, electric shock or other personal injury.

5. Water and/or Moisture

Do not use this equipment near water or in contact with water.

6. Accessories

Do not place this equipment on an unstable cart, stand or table. The equipment may fall, causing serious injury to a child or adult, and serious damage to the equipment. Wall or shelf mounting should follow the manufacturer's instructions, and should use a mounting kit approved by the manufacturer.



This equipment and cart combination should be moved with care. Quick stops, excessive force, and uneven surfaces may cause the equipment and cart combination to overturn.

7. Power Sources

This equipment should be operated only from the type of power source indicated on the marking label. If you are not sure of the type of power, please consult your equipment dealer or local power company.

8. Power Cords

Operator or installer must remove power and TNT connections before handling the equipment.

9. Lightning

For added protection for this equipment during a lightning storm, or when it is left unattended and unused for long periods of time, unplug it from the wall outlet and disconnect the antenna or cable system. This will prevent damage to the equipment due to lightning and power-line surges.

10. Overloading

Do not overload wall outlets and extension cords as this can result in the risk of fire or electric shock.

11. Objects and Liquids

Never push objects of any kind through openings of this equipment as they may touch dangerous voltage points or short out parts that could result in a fire or electric shock. Never spill liquid of any kind on the equipment.

12. Servicing

Do not attempt to service this equipment yourself. Refer all servicing to qualified service personnel.

13. Damage requiring Service

Unplug this equipment from the wall outlet and refer servicing to qualified service personnel under the following conditions:

- A. When the power-supply cord or the plug has been damaged.
- B. If liquid is spilled, or objects have fallen into the equipment.
- C. If the equipment has been exposed to rain or water.
- D. If the equipment does not operate normally by following the operating instructions, adjust only those controls that are covered by the operating instructions as an improper adjustment of other controls may result in damage and will often require extensive work by a qualified technician to restore the equipment to its normal operation.
- E. If the equipment has been dropped, or the cabinet damaged.
- F. When the equipment exhibits a distinct change in performance — this indicates a need for service.

14. Replacement Parts

When replacement parts are required, be sure the service technician has used replacement parts specified by the manufacturer or that have the same characteristics as the original part. Unauthorized substitutions may result in fire, electric shock or other hazards.

15. Safety Check

Upon completion of any service or repairs to this equipment, ask the service technician to perform safety checks to determine that the equipment is in proper operating condition.

16. Field Installation

This installation should be made by a qualified service person and should conform to all local codes.

17. Correct Batteries

Warning: Risk of explosion if battery is replaced by an incorrect type. Dispose of used batteries according to the instructions.

18. Tmra

A manufacturer's maximum recommended ambient temperature (Tmra) for the equipment must be specified so that the customer and installer may determine a suitable maximum operating environment for the equipment.

19. Elevated Operating Ambient Temperature

If installed in a closed or multi-unit rack assembly, the operating ambient temperature of the rack environment may be greater than room ambient. Therefore, consideration should be given to installing the equipment in an environment compatible with the manufacturer's maximum rated ambient temperature (Tmra).

20. Reduced Air Flow

Installation of the equipment in the rack should be such that the amount of airflow required for safe operation of the equipment is not compromised.

21. Mechanical Loading

Mounting of the equipment in the rack should be such that a hazardous condition is not caused by uneven mechanical loading.

22. Circuit Overloading

Consideration should be given to connection of the equipment to supply circuit and the effect that overloading of circuits might have on over current protection and supply wiring. Appropriate consideration of equipment nameplate ratings should be used when addressing this concern.

23. Reliable Earthing (Grounding)

Reliable grounding of rack mounted equipment should be maintained. Particular attention should be given to supply connections other than direct connections to the branch circuit (e.g., use of power strips).

Table of Contents

Chapter 1 — Introduction	1
Features	1
Technical Overview	2
Chapter 2 — Installation	3
Package Contents	3
Required Installation Tools	3
Connecting the Video Source	3
Connecting the Loop Through Video	4
Connecting Audio	4
Setting Unit for CVBS (SVHS) or VGA output	4
Connecting the Monitor	5
Connecting the Spot Monitor	5
Connecting the RGB Monitor	5
Connecting to the Network Port	6
Connecting to the RS-232C Port	6
Factory Reset	6
Connecting Alarms	7
AI 1 to 4 (Alarm In)	7
GND (Ground)	7
ARI (Alarm Reset In)	8
Alarm Out	8
Connecting to the RS-485 Port	8
Connecting to the USB Port	9
Connecting the Power Cord	9
Chapter 3 — Configuration	11
Front Panel Controls	11
Power LED	11
Alarm LED	11
REC LED	11
Network LED	11
Copy LED	12
Camera Buttons (1 to 4)	12
QUAD/SEQ Button	12
PTZ Button	12
PANIC Button	12
Menu Button	12
Enter/Pause Button	13
Arrow Buttons	13
Shuttle Ring	13
Jog Dial	13

Turning on the Power	14
Initial Unit Setup	14
Quick Setup Screen	14
Normal Setup Screen	16
System Information	16
Date/Time Setup	19
System Check Screen	22
Storage Screen	23
System Log Screen	25
System Shutdown	25
Configuring Input Devices	26
Camera Setup Screen	26
Alarm In Setup Screen	27
Motion Detector	28
Text-In Setup Screen	29
Alarm Out Setup Screen	32
Audio Setup Screen	33
RS232/RS485 Setup Screen	34
Configuring Recording Settings	35
Record Mode Setup Screen	35
Time-Lapse Record Mode Setup Screen	36
Time-Lapse Recording Schedule	37
Pre-Event Recording Setup Screen	38
Event Action Setup	39
Alarm In Event Action (Record) Setup Screen	39
Alarm In Event Action (Alarm Out) Setup Screen	40
Alarm In Event Action (Notify) Setup Screen	40
Motion Detector Event Action (Record) Setup Screen	41
Motion Detector Event Action (Alarm Out) Setup Screen	42
Motion Detector Event Action (Notify) Setup Screen	42
Text-In Event Action (Record) Setup Screen	43
Text-In Event Action (Alarm Out) Setup Screen	44
Text-In Event Action (Notify) Setup Screen	44
Video Loss Event Action (Record) Setup Screen	45
Video Loss Event Action (Alarm Out) Setup Screen	46
Video Loss Event Action (Notify) Setup Screen	46
Display Setup	47
OSD (On-Screen Display) Setup	47
Main Monitoring Setup Screen	48
Network Setup Screen	49
LAN Setup Screen	50
Modem Setup	53
DVRNS (DVR Name Service) Setup Screen	54
Callback Center Setup Screen	55
Password Setup Screen	57

Config Screen	58
Clip Copy	58
Load Default Setup	60
Clear All Data	60
Chapter 4 — Operation	61
Turning on the Power	61
Live Monitoring	61
PTZ Mode	62
Digital Zoom Mode	64
Recording Video	64
Recording Audio	65
Playing Recorded Video	65
Arrow Buttons	65
Enter Button	66
Camera Buttons (1 to 4)	66
QUAD/SEQ Button	66
Shuttle Ring	66
Jog Dial	66
Digital Zoom Playback Mode	66
Searching Video	67
Date/Time Search	68
Calendar Search	68
Event Search	70
Text-In Search	72
Appendix A — USB Hard Disk Drive Preparation	74
Preparing the USB-IDE hard disk drive in Windows 2000	74
Preparing the USB-IDE hard disk drive in Windows 98	74
Appendix B — Text-In Query Examples	76
Query Example I	76
Query Example II	77
Appendix C — Troubleshooting	78
Appendix D — Connector Pin Outs	79
I/O Connector Pin Outs	79
RS485 Connector Pin Outs	79
Appendix E — Map of Screens	80
Appendix F — Specifications	81

List of Illustrations

Figure 1 — Typical DVR installation	1
Figure 2 — DVR rear panel	3
Figure 3 — Video input connectors	3
Figure 4 — Video Loop Through connectors	4
Figure 5 — Audio In and Out connectors	4
Figure 6 — CVBS (SVHS)/VGA switch	4
Figure 7 — Video Out connectors	5
Figure 8 — VGA connector	5
Figure 9 — Network connector	6
Figure 10 — RS-232C connector	6
Figure 11 — Factory reset switch	6
Figure 12 — Alarm Input connector strips	7
Figure 13 — Alarm Output connector strips	8
Figure 14 — RS-485 Connector	8
Figure 15 — USB connector	9
Figure 16 — Power cord connector	9
Figure 17 — DVR front panel	11
Figure 18 — Admin Password screen	14
Figure 19 — Quick Setup screen	14
Figure 20 — Normal Setup screen	16
Figure 21 — System Information screen	16
Figure 22 — System Information Change screen	17
Figure 23 — Virtual keyboard	17
Figure 24 — System Upgrade screen	18
Figure 25 — Date/Time setup screen	19
Figure 26 — Holiday Setup screen	20
Figure 27 — Time Sync screen	20
Figure 28 — System Check screen	22
Figure 29 — Storage screen	23
Figure 30 — S.M.A.R.T. Setup screen	24
Figure 31 — System Log screen	25
Figure 32 — Device menu screen	26
Figure 33 — Camera setup screen	26
Figure 34 — PTZ Device list	27
Figure 35 — Alarm In setup screen	27
Figure 36 — Motion Detector setup screen	28
Figure 37 — Motion Detection Zone screen	28
Figure 38 — Text-In Setup screen	29
Figure 39 — Text-In (Generic Text) Setup screen	30
Figure 40 — Text-In (E-POS) Setup screen	31
Figure 41 — Alarm Out setup screen	32
Figure 42 — Alarm Out Schedule screen	32
Figure 43 — Audio Setup screen	33
Figure 44 — RS232/RS485 setup screen	34
Figure 45 — Record Mode Setup screen	35
Figure 46 — Time-Lapse Record Setup screen	36
Figure 47 — Time-Lapse Recording Schedule screen	37
Figure 48 — Pre-Event Record Setup screen	38
Figure 49 — Alarm In Event Action (Record) setup screen	39

Figure 50 — Alarm In Event Action (Alarm Out) setup screen.....	40
Figure 51 — Alarm In Event Action (Notify) setup screen.....	40
Figure 52 — Motion Detector Event Action (Record) setup screen.....	41
Figure 53 — Motion Detector Event Action (Alarm Out) setup screen.....	42
Figure 54 — Motion Detector Event Action (Notify) setup screen.....	42
Figure 55 — Text-In Event Action (Record) setup screen.....	43
Figure 56 — Text-In Event Action (Alarm Out) setup screen.....	44
Figure 57 — Text-In Event Action (Notify) setup screen.....	44
Figure 58 — Video Loss Event Action (Record) setup screen.....	45
Figure 59 — Video Loss Event Action (Alarm Out) setup screen.....	46
Figure 60 — Video Loss Event Action (Notify) setup screen.....	46
Figure 61 — OSD Setup screen.....	47
Figure 62 — Main Monitoring Setup screen.....	48
Figure 63 — Network Setup screen.....	49
Figure 64 — LAN (Manual) Setup screen.....	50
Figure 65 — Port Number Setup screen.....	51
Figure 66 — LAN (DHCP) Setup screen.....	52
Figure 67 — LAN (ADSL) Setup screen.....	52
Figure 68 — Modem Setup screen.....	53
Figure 69 — DVRNS Setup screen.....	54
Figure 70 — Callback Center (LAN) Setup screen.....	55
Figure 71 — Callback Center (Modem) Setup screen.....	56
Figure 72 — Password setup screen.....	57
Figure 73 — Config screen.....	58
Figure 74 — Clip Copy screen.....	58
Figure 75 — Disk Partition Selection screen.....	59
Figure 76 — Live Monitoring (Text-In) screen.....	62
Figure 77 — PTZ Menu.....	63
Figure 78 — PTZ Preset screen.....	63
Figure 79 — Preset view screen.....	63
Figure 80 — PTZ speed controller.....	64
Figure 81 — Playback (Text-In) screen.....	65
Figure 82 — Digital Zoom screen.....	67
Figure 83 — Enlarged Digital Zoom screen.....	67
Figure 84 — Search Menu.....	67
Figure 85 — Date/Time Search screen.....	68
Figure 86 — Calendar Search screen.....	69
Figure 87 — Event Log screen.....	70
Figure 88 — Event Search (by Event) screen.....	71
Figure 89 — Event Search (by Camera) screen.....	71
Figure 90 — Text-In Log screen.....	72
Figure 91 — Text-In Search screen.....	72

Chapter 1 — Introduction

Features

Your color digital video recorder (DVR) provides recording capabilities for 4 camera inputs. It provides exceptional picture quality in both live and playback modes, and offers the following features:

- 4 Composite Input Connectors
- Auto detectable for NTSC or PAL
- Compatible with Color (NTSC or PAL) and B&W (CCIR and EIA-170) Video Sources
- Multiple Search Engines (Date/Time, Calendar, Event)
- Records up to 120 NTSC Images per Second (100 PAL Images per Second)
- “Loop-Through” Video Connectors
- Continuous Recording in Disk Overwrite Mode
- Continues Recording while Archiving, Transmitting to Remote Site and during Playback
- User-friendly Graphical User Interface (GUI) Menu System
- Various Record Modes (Time, Event, Pre-event and Panic)
- Audio Recording and Playback
- Alarm Connections Include: Input, Output and Reset Input
- Built-in Alarm Buzzer
- Live or Recorded Video Access via Ethernet or Modem

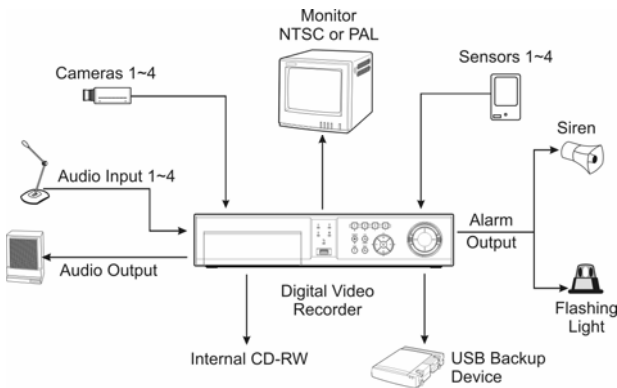

Figure 1 — Typical DVR installation.

Technical Overview

Your DVR can replace both a time-lapse VCR and a multiplexer in a security installation. However, it has many features that make it much more powerful and easier to use than even the most advanced VCR.

The DVR converts analog NTSC or PAL video to digital images and records them on a hard disk drive. Using a hard disk drive allows you to access recorded video almost instantaneously; there is no need to rewind tape. The technology also allows you to view recorded video while the DVR continues recording video.

Digitally recorded video has several advantages over analog video recorded on tape. There is no need to adjust tracking. You can freeze frames, fast forward, fast reverse, slow forward and slow reverse without image streaking or tearing. Digital video can be indexed by time or events, and you can instantly view video after selecting the time or event.

Your DVR can be set up for event or time-lapse recording. You can define times to record, and the schedule can change for different days of the week and user defined holidays.

The DVR can be set up to alert you when the hard disk drive is full, or it can be set up to record over the oldest video once the disk is full.

Your DVR uses a proprietary encryption scheme making it nearly impossible to alter video.

You can view live video, search image, and control your DVR remotely by connecting via external modem or Ethernet. There is a USB port that can be used to back up the clip file video to USB-IDE hard disk drives, USB CD-RW drives or flash drives.

Chapter 2 — Installation

Package Contents

The package contains the following:

- Digital Video Recorder
- Power Cord
- User's Manual (This Document)
- RAS Software CD and User's Manual
- Rack-mount Kit
- Assembly Screws for Adding Hard Disk Drives

Required Installation Tools

No special tools are required to install the DVR. Refer to the installation manuals for the other items that make up part of your system.

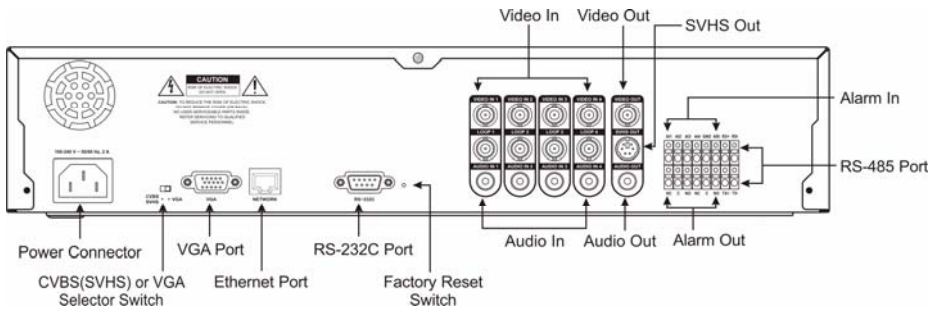

Figure 2 — DVR rear panel.

Connecting the Video Source



Figure 3 — Video input connectors.

Connect the coaxial cables from the video sources to the BNC Video In connectors.

Connecting the Loop Through Video



Figure 4 — Video Loop Through connectors.

If you would like to connect your video source to another device, you can use the Loop BNC connectors.

NOTE: The Loop BNC connectors are auto terminated. Do NOT connect a cable to the Loop BNC unless it is connected to another terminated device because it will cause poor quality video.

Connecting Audio

NOTE: It is the user's responsibility to determine if local laws and regulations permit recording audio.



Figure 5 — Audio In and Out connectors.

Your DVR can record audio. Connect the audio source to Audio In. Connect Audio Out to your amplifier.

NOTE: The audio input is from an amplified source. The DVR does not have amplified audio output, so you will need a speaker with an amplifier.

Setting Unit for CVBS (SVHS) or VGA output

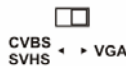

Figure 6 — CVBS (SVHS)/VGA switch.

Set the switch to CVBS (SVHS) or VGA for monitor output. Select CVBS (SVHS) for spot monitor, and select VGA for RGB monitor.

NOTE: The DVR may not support some LCD monitors or some monitors don't support Multi Sync.

NOTE: You cannot use spot monitor output and VGA output at the same time.

NOTE: Set the CVBS (SVHS) or VGA selector switch before turning on the DVR. You cannot change the setting while the unit is running.

Connecting the Monitor

Connecting the Spot Monitor



Figure 7 — Video Out connectors.

Connect the SPOT monitor to either the Video Out or SVHS Out connector.

NOTE: For SPOT monitor Output, set the CVBS (SVHS)/VGA selector switch to the CVBS (SVHS).

NOTE: If your monitor has an SVHS input, use it because it will give you better quality video display.

NOTE: The *Video Out* (BNC) and the *SVHS Out* connectors may be connected to individual monitors for simultaneous operation.

Connecting the RGB Monitor

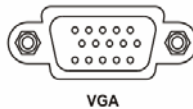

Figure 8 — VGA connector.

A VGA port is provided for RGB monitor output. Connect the RGB monitor to the VGA connector if required. Connect an RGB cable with a DB-15 (male) connector, which is usually less than 10 feet, to the DVR connector.

NOTE: For RGB monitor output, set the CVBS (SVHS)/VGA selector switch to the VGA.

Connecting to the Network Port



Figure 9 — Network connector.

The DVR can be networked using the 10/100Mb Ethernet connector. Connect a Cat5 cable with an RJ-45 jack to the DVR connector. The DVR can be networked with a computer for remote monitoring, searching, configuration and software upgrades. See *Chapter 3 — Configuration* for configuring the Ethernet connections.

Connecting to the RS-232C Port

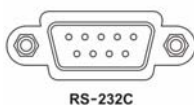

Figure 10 — RS-232C connector.

An RS-232C port is provided to connect an external modem for remote monitoring, configuration and software upgrades, text input, and to connect a remote control keyboard. Use a modem cable with a DB-9S (female) connector to connect to the DVR. See *Chapter 3 — Configuration* for configuring the modem.

NOTE: The DVR is not supplied with a modem cable, and many modems are not supplied with cables. Make certain you have the correct cable when purchasing the modem.

Factory Reset

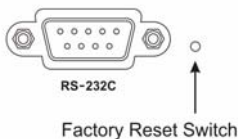

Figure 11 — Factory reset switch.

The DVR has a Factory Reset switch to the right of the RS-232C connector. This switch will only be used on the rare occasions that you want to return all the settings to the original factory settings.

CAUTION: When using the *Factory Reset*, you will lose any setting you have made. If you want to use the same DVR name registered on the DVRNS server after initializing the system using the factory reset, you need to contact the DVRNS server manager. Please record and keep the help desk information before factory reset.

To reset the unit, you will need a straightened paperclip:

1. Turn the DVR off.
2. Turn it on again.
3. While the DVR is initializing, poke the straightened paperclip in the unlabeled hole to the right of the RS-232C connector.
4. Hold the switch until all the LEDs on the Front Panel are lit.

NOTE: When the DVR successfully resets to factory defaults all the LEDs on the Front Panel flash three times.

5. Release the reset switch. All of the DVR's settings are now at the original settings it had when it left the factory.

Connecting Alarms



Figure 12 — Alarm Input connector strips.

NOTE: To make connections on the Alarm Connector Strip, press and hold the button and insert the wire in the hole below the button. After releasing the button, tug gently on the wire to make certain it is connected. To disconnect a wire, press and hold the button above the wire and pull out the wire.

AI 1 to 4 (Alarm In)

You can use external devices to signal the DVR to react to events. Mechanical or electrical switches can be wired to the AI (Alarm In) and GND (Ground) connectors. The threshold voltage for NC (Normally Closed) is above 4.3V and should be stable at least 0.5 seconds to be detected. For NO (Normally Open), the threshold voltage is below 0.3V. See *Chapter 3 — Configuration* for configuring alarm input.

GND (Ground)

Connect the ground side of the Alarm input to the GND connector.

ARI (Alarm Reset In)

An external signal to the **Alarm Reset In** can be used to reset both the Alarm Out signal and the DVR's internal buzzer. Mechanical or electrical switches can be wired to the **ARI (Alarm Reset In)** and **GND (Ground)** connectors. The threshold voltage is below 0.3V and should be stable at least 0.5 seconds to be detected. Connect the wires to the **ARI (Alarm Reset In)** and **GND (Ground)** connectors.

Alarm Out

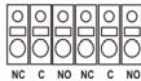

Figure 13 — Alarm Output connector strips.

The DVR can activate external devices such as buzzers or lights. Mechanical or electrical switches can be wired to the **NC (Normally Closed)** and **C (Common)** connectors or **NO (Normally Open)** and **C (Common)** connectors. Permitted current is up to 0.5 A for 125 VAC, 1 A for 30 VDC. See *Chapter 3 — Configuration* for configuring alarm output.

Connecting to the RS-485 Port



Figure 14 — RS-485 Connector.

The DVR can be controlled remotely by an external device or control system, such as a control keyboard, using RS-485 half-duplex serial communications signals. The RS-485 connector can also be used to control PTZ (pan, tilt, zoom) cameras. Connect **RX-/TX-** and **RX+/TX+** of the control system to the **TX-/RX-** and **TX+/RX+** (respectively) of the DVR. See *Chapter 3 — Configuration* and the PTZ camera or remote controller manufacturer's manual for configuring the RS-485 connection.

Connecting to the USB Port



Figure 15 — USB connector.

A USB port on the front panel is provided to connect external hard disk drives, CD-RW drives or flash drives for archiving video. Position the external hard disk drive close enough to the DVR so that you can make the cable connections, usually less than 6 feet. Use the USB cable provided with the hard disk drive or CD-RW to connect it to the DVR. See *Chapter 4 — Operation* for archiving video to an external USB-IDE hard disk drive, USB CD-RW drive or USB flash drive. You also can upgrade the software via USB port.

Connecting the Power Cord

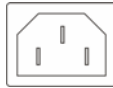

Figure 16 — Power cord connector.

Connect the power cord to the DVR and then to the wall outlet.

WARNING: ROUTE POWER CORDS SO THAT THEY ARE NOT A TRIPPING HAZARD. MAKE CERTAIN THE POWER CORD WILL NOT BE PINCHED OR ABRADED BY FURNITURE. DO NOT INSTALL POWER CORDS UNDER RUGS OR CARPET.

THE POWER CORD HAS A GROUNDING PIN. IF YOUR POWER OUTLET DOES NOT HAVE A GROUNDING PIN RECEPTACLE, DO NOT MODIFY THE PLUG. DO NOT OVERLOAD THE CIRCUIT BY PLUGGING TOO MANY DEVICES IN TO ONE CIRCUIT.

Your DVR is now ready to operate. Refer to *Chapter 3 — Configuration* and *Chapter 4 — Operation*.

Chapter 3 — Configuration

NOTE: Your DVR should be completely installed before proceeding. Refer to *Chapter 2 — Installation*.

Front Panel Controls

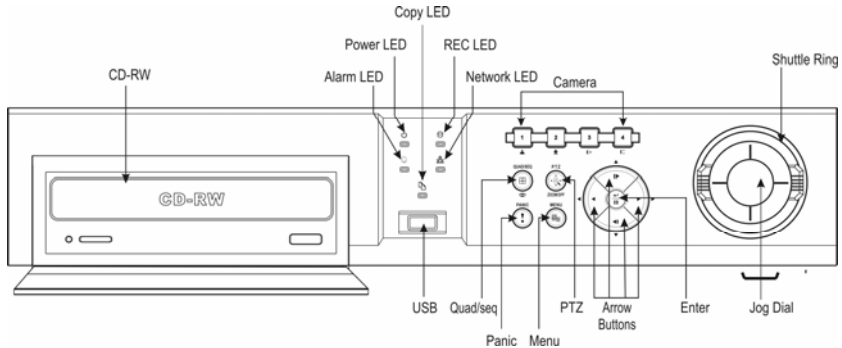

Figure 17 — DVR front panel.

Many of the buttons on the front panel have multiple functions. The following describes each button and control. Take a few minutes to review the descriptions. You will use these to initially set up your DVR and for daily operations.

NOTE: A separate Alarm button is not provided. Pressing any keys on the front panel resets alarm output including the internal buzzer when the alarm is activated. However, when you are in the menu or PTZ mode, you have to exit the menu or PTZ mode first to reset alarm output.

Power LED

The POWER LED is lit when the DVR is On.

Alarm LED

The ALARM LED is lit when alarm output or internal buzzer is activated.

REC LED

The REC LED is lit when the DVR is recording. When the DVR is in the panic recording mode, the RCE LED flickers.

Network LED

The NETWORK LED is lit when the unit is networked either via Ethernet or modem.

Copy LED

The Copy LED is lit when data is being backed up using the internal CD-RW or the USB port.

Camera Buttons (1 to 4)

Pressing the individual camera buttons will cause the selected camera to display full screen. They are used to enter passwords. The camera buttons also function in the PTZ mode. Pressing **CAMERA 1** zooms in in the PTZ mode, and pressing **CAMERA 2** zooms out in the PTZ mode. **CAMERA 3** is used to control near focus of the PTZ camera in the PTZ mode. **CAMERA 4** is used to control far focus of the PTZ camera in the PTZ mode.

QUAD/SEQ Button

Pressing the **QUAD/SEQ** button toggles between quad (2x2) display mode and sequence mode. It also loads a Preset View in the PTZ mode.

PTZ Button

Pressing the **PTZ** button opens a Pan/Tilt/Zoom screen which allows you to control properly configured cameras.

In the PTZ mode, pressing the **PTZ** button enters the digital zoom mode, and pressing the button again in the digital zoom mode returns to the live monitoring mode. When a PTZ device is not installed, pressing the **PTZ** button enters the digital zoom mode directly.

Pressing the **PTZ** button in the playback mode enters the digital zoom playback mode.

NOTE: When the DVR is in the PTZ mode, a white line will display around the image.

NOTE: In the digital zoom mode and digital zoom playback mode, a bright small box is laid over the image. The box indicates the area to be enlarged.

PANIC Button

Pressing the **PANIC** button activates panic recording, so the DVR will record video regardless of the time-lapse or event recording schedule. Press the button again to release the panic recording.

NOTE: When the DVR is recording video, a red dot appears on the screen. When the DVR is in the panic recording mode, a white ! appears in the red dot, and the REC LED on the front panel flickers.

Menu Button

Pressing the **MENU** button enters the Main Menu. You will need to enter the administrator password to access the Main Menu. Pressing the button again closes the current menu or setup dialog box. It is also used to display the search menu in the playback mode, and load the PTZ Menu in the PTZ mode.

Enter/Pause Button

This button selects a highlighted item or completes an entry that you have made. Pressing the **ENTER/PAUSE** button in the live monitoring mode freezes the current live screen, and the screen displays *** .** Press the button again to return to the live monitoring mode.

Pressing the button in the playback mode will pause the video, and the screen displays **||**. Pressing **ENTER/PAUSE** button again in the pause mode goes to the live monitoring mode.

In the digital zoom mode, pressing the button enlarges a specific area of the screen. A **⊕** displays on the enlarged screen.

Arrow Buttons

Arrow buttons are used to navigate through menus and GUI. They are also used to control Pan and Tilt in the PTZ mode, and to move the specific part of screen that you want to enlarge in the digital zoom mode.

In the playback mode, the **Up-Arrow** button selects the next image, and the **Down-Arrow** button selects the previous image. Pressing the **Left-Arrow** button plays video backward at high speed. Pressing the button again toggles the playback speed from **◀◀**, **◀◀◀** and **◀◀◀◀**. The screen displays **◀◀**, **◀◀◀** and **◀◀◀◀** respectively. Pressing the **Right-Arrow** button plays video forward at high speed. Pressing the button again toggles the playback speed from **▶▶**, **▶▶▶** and **▶▶▶▶**. The screen displays **▶▶**, **▶▶▶** and **▶▶▶▶** respectively.

Entering Playback mode from Live Monitoring mode can be user password protected.

Shuttle Ring

The Shuttle Ring functions in the Playback mode. The Shuttle Ring is spring loaded and returns to the center position when released. When you release the ring, it snaps back to the center position and the video pauses. Turning the ring clockwise plays video forward. Turning the ring counterclockwise plays video backward. Playback speed varies with the amount the ring is turned. The playback speeds are **◀x0.5**, **◀◀**, **◀◀◀**, **◀◀◀◀**, **▶x0.5**, **▶**, **▶▶**, **▶▶▶** and **▶▶▶▶**.

Jog Dial

The Jog Dial functions when playback video has been paused. By turning the jog dial clockwise, you can play video forward image-by-image. By turning the jog dial counterclockwise, you play video backward image-by-image.

The Jog Dial also can be used to change numerical values such as IP addresses, date/time and page during the system setup.

Turning on the Power

Connecting the power cord to the DVR turns on the unit. The unit will take approximately 60 seconds to initialize.

Initial Unit Setup

Before using your DVR for the first time, you will want to establish the initial settings. This includes items such as time and date, display language, camera, audio, remote control, record mode, network and password. Your DVR can be set up using various screens and dialog boxes.

Press the **MENU** button to enter the setup screens. The Admin Password screen appears.

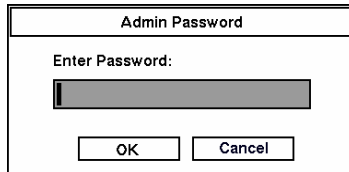

Figure 18 — Admin Password screen.

Enter the password by pressing the appropriate combination of camera number buttons and then the **+** button. The factory default password is 4321. There are two Setup screens: Quick Setup and Normal Setup. The factory default is the Quick Setup screen.

Quick Setup Screen

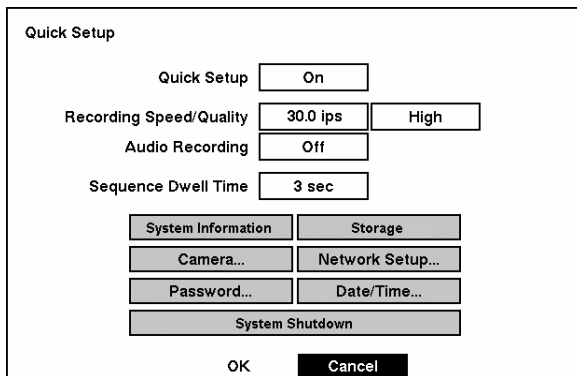

Figure 19 — Quick Setup screen.

The **Quick Setup** screen allows you to set up the most commonly used features of your DVR. Use the arrow buttons to move through the options. Pressing the **↔** button lets you make your selections.

Highlight the box beside **Quick Setup** and press the **↔** button to toggle between **On** and **Off**. If you select **Off**, you will use the **Normal Setup** screen to change the DVR's settings.

Highlight the first box beside **Recording Speed/Quality**, and select recording speeds from as few as 0.5 ips to as fast as 30 ips (25 ips for PAL).

NOTE: The DVR has a maximum recording speed of 30 ips per camera; however, the recording speed may not be achieved when averaged over all cameras.

Highlight the second box beside **Recording Speed/Quality**, and select from **Very High**, **High**, **Standard** and **Low**.

Highlight the box beside **Audio Recording** and select either **On** or **Off**.

NOTE: It is the user's responsibility to determine if local laws and regulations permit recording audio.

Highlight the box beside **Sequence Dwell Time** and select from 3 to 60 seconds for the camera sequence dwell time.

Selecting **System Information** enters a screen where you can set up system information.

Selecting **Storage...** enters a screen where you can check the storage status.

Selecting **Camera...** enters a screen where you can set up camera information.

Selecting **Network Setup...** enters a screen where you can set up network information.

Selecting **Password...** enters a screen where you will be able to change passwords.

Selecting **Date/Time...** enters a screen where you will be able to set the DVR's time and date.

Selecting **System Shutdown** shuts the DVR down. When shutting down the DVR, you need to confirm that you want to shut down the unit, you will be asked for an administrator password.

NOTE: The *Quick Setup* mode will be released automatically when the user changes the DVR settings remotely using the RAS (Remote Administration System) program.

Normal Setup Screen

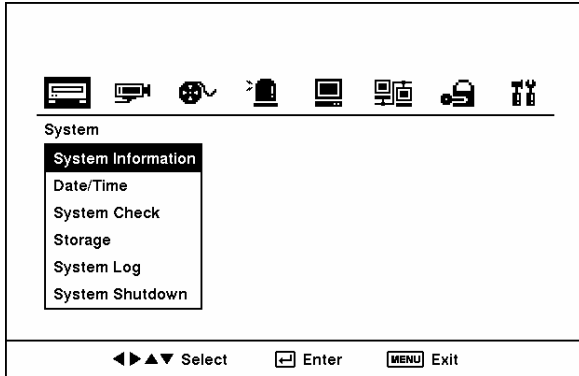

Figure 20 — Normal Setup screen.

Press the **MENU** button to enter the setup screen. If the Quick Setup screen appears, turn it off as described above. The Normal Setup screen gives you access to all the DVR's setup screens.

System Information

Highlight System Information and press the **Enter** button. The System Information screen appears.

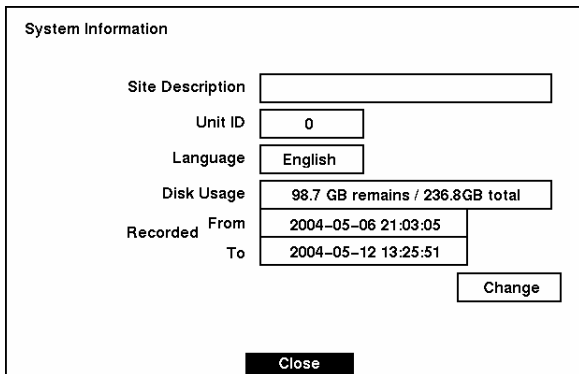

Figure 21 — System Information screen.

In the System Information screen, you can upgrade the software, name the site location, assign a unit ID number and select the language to use. Highlight Change and press the **Enter** button. The System Information Change screen appears.

System Information Change

Site Description

Unit ID

Language

H/W Version

S/W Version

OK

Figure 22 — System Information Change screen.

Highlight the box beside Site Description and press the button. A virtual keyboard displays.

Site Description

Site 01

a	b	c	d	e	f	g	h	i	j	k	l	M
n	o	p	q	r	s	t	u	v	w	x	y	Z
1	2	3	4	5	6	7	8	9	0	-	=	\
[]	:	'	,	.	/	'					Space

Figure 23 — Virtual keyboard.

Use the arrow keys to highlight the first character you want in the Site Title and press the button. That character appears in the title bar and the cursor moves to the next position. Pressing toggles between the upper and lower case keyboards, backspaces, and deletes entered characters. You can use up to 20 characters including spaces in your title.

Once you have entered your title, highlight Close and press the button.

Highlight the box beside Unit ID and adjust the number. The Unit ID number is used to identify the unit when it is networked with other DVRs. You cannot use the same number for two or more DVRs that are within the same network.

Highlight the box beside Language and press button. A dropdown menu displays the available languages. Highlight the desired language and press the button.

The box beside H/W Version and S/W Version field displays the hardware and software version of DVR.

NOTE: You can upgrade the software only in the System Information Change screen.

To upgrade the software, connect the USB device which containing the upgrade package file to the DVR. Highlight Upgrade... and press the  button. The System Upgrade screen appears. The screen displays the upgrade package file name.

NOTE: If no hard disk drives are installed on the DVR, the *Upgrade...* button will be disabled.

NOTE: If the file system on the USB-IDE hard disk drive or USB flash drive is NOT FAT16 or FAT32 format, format the device using FAT16 or FAT32 format.

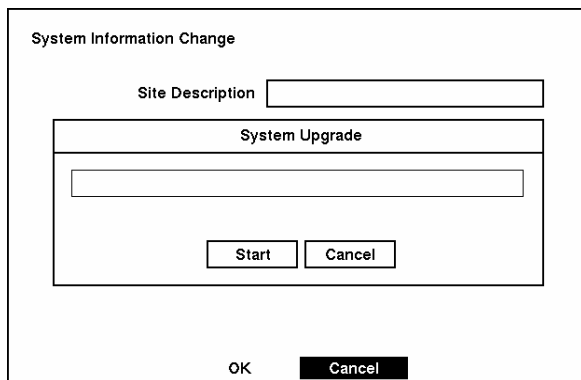



Figure 24 — System Upgrade screen.

Select **Start**, and enter the Admin password to start the upgrade.

The system restarts automatically after completing the upgrade. The software will start running after restarting the unit.

NOTE: Only the system administrator can upgrade the software.

NOTE: You cannot upgrade the software during clip copy.

You can save your changes by highlighting **OK** and pressing the  button. Selecting **Cancel** exits the screen without saving the changes.

Date/Time Setup

Highlight Date/Time in the Main menu and press the **[↔]** button. The Date/Time setup screen appears.

Date/Time	2004-03-17	00:05:19
Time Zone	GMT-05:00 Eastern Time (US & Cana)	
Daylight Saving Time	Off	
	Holiday Setup...	
	Time Sync...	
Date Format	YYYY-MM-DD	
Time Format	24 Hours	
OK	Cancel	

Figure 25 — Date/Time setup screen.

CAUTION: If you set a date and time that is older than some of your recorded images, any images with dates and times later than the new setting will be deleted.

Highlight the first box beside Date/Time and press the **[↔]** button. The individual sections of the date highlight. To adjust the numbers, you can use the arrow buttons or Jog Dial. Once you have the correct date, press the **[↔]** button.

Highlight the second box beside Date/Time and press the **[↔]** button. The individual sections of the time will highlight. To adjust the numbers, you can use the arrow buttons or Jog Dial. Once you have the correct time, press the **[↔]** button.

NOTE: The clock will not start running until you have restarted the unit, so you may wish to set the time last.

Highlight the box beside Time Zone and press the **[↔]** button. Select the time zone you are in from the list and press the **[↔]** button.

Highlight the box beside Daylight Saving Time and press the **[↔]** button. Pressing the **[↔]** button toggles between On and Off.

Highlight the Holiday Setup... box and press the **[↔]** button. You can set up holidays by highlighting Add: and pressing the **[↔]** button. The current date appears.

Highlight the month and day and change them by using the arrow buttons. Press the **[↔]** button to add the date. Dates can be deleted by highlighting the X beside the date and pressing the **[↔]** button.

NOTE: Holidays that do not fall on the same date each year should be updated once the current year's holiday has passed.

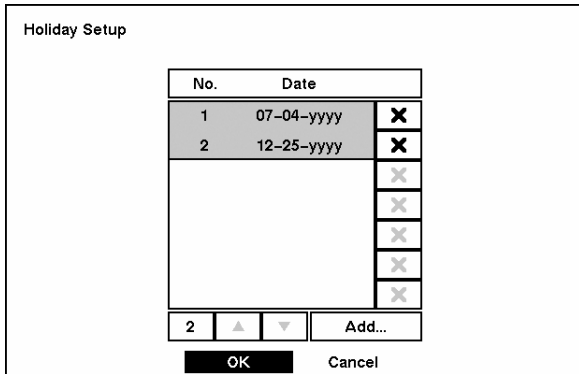

Figure 26 — Holiday Setup screen.

You can save your changes by highlighting OK and pressing the button. Selecting Cancel exits the screen without saving the changes.

Highlight the Time Sync... box and press the button. You can set up time synchronization between the DVR and standard time servers that are available in most time zones and countries, or between the DVR and another DVR.

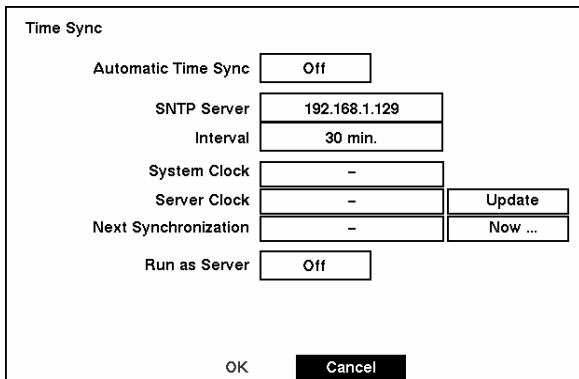

Figure 27 — Time Sync screen.

Highlight the box beside Automatic Time Sync and press the button. This toggles between On and Off.

Highlight the box beside SNTP Server and press the button. Change the numbers by highlighting them and using the Up and Down arrow buttons to increase or decrease the number value.

Highlight the box beside Interval and press the button. Set the time interval for synchronization from 30 to 300 minutes.

The box beside **System Clock** displays the DVR's time setting.

The box beside **Server Clock** displays the time setting of the time server. Highlighting the **Update** button and pressing the button updates the server clock.

NOTE: The *Server Clock* will display “ – ” when the DVR cannot load the time information from the time server.

The box beside **Next Synchronization** displays the time when the next synchronization is scheduled. If you want to synchronize the time instantly, highlight the **NOW...** button and press the button.

CAUTION: When selecting *Now...*, any video with a later time and date will be lost if the time and date of a time server is earlier than the last recorded image of the DVR.

NOTE: When the time difference between the DVR and the time server is more than one minute, the DVR might not synchronize the time to prevent any unexpected loss of recorded video data. If you want to synchronize the time manually, select *Now...*

Highlight the **Run as Server** box and press the button. Pressing the button toggles between **On** and **Off**. When it is **On**, the DVR you are setting up will run as a time server.

You can save your changes by highlighting **OK** and pressing the button. Selecting **Cancel** exits the screen without saving the changes.

Highlight the box beside **Date Format** and press the button. A list of date formats appears. Highlight the format you wish to use and press the button. The choices are:

MM-DD-YYYY
 DD-MM-YYYY
 YYYY-MM-DD
 MM/DD/YYYY
 DD/MM/YYYY
 YYYY/MM/DD

To change the time format, highlight the box beside **Time Format** and press the button. The DVR toggles between **12 Hours (AM/PM)** and **24 Hours (military time)**.

You can save your changes by highlighting **OK** and pressing the button. Selecting **Cancel** exits the screen without saving the changes.

System Check Screen

Highlight **System Check** in the Main menu and press the  button. The **System Check** setup screen appears.

System Check

Check Point	On/Off	Interval	Status
Record	Off	1 Hour	
Alarm In 1	Off	1 Hour	
Alarm In 2	Off	1 Hour	
Alarm In 3	Off	1 Hour	
Alarm In 4	Off	1 Hour	

On Record Problem :



Alarm Out / Notify

Figure 28 — System Check screen.

Highlight the box under the **On/Off** heading and press the  button. This toggles between **On** and **Off**. When it is **On**, the DVR reports a fault condition if it does not detect any recording or if there is an alarm during the designated time.

Highlight the box under the **Interval** heading and press the  button. A slide bar appears allowing you to set the check interval from 1 Hour to 30 Days.

The **Status** field displays the fault conditions. When it is **Good**, there was recording or an alarm occurred during the designated time. When it is **Bad**, there was no recording or no alarm occurred during the designated time.

Highlight the box beside the **On Record Problem: Alarm Out** and press the  button. A drop menu displays the available alarm outputs for the recording problem. Highlight the desired alarm output from no alarm output, external alarm out terminal, internal buzzer or notify, and press the  button.

Storage Screen

Highlight **Storage** in the Main menu and press the  button. The **Storage** setup screen appears.

No.	Type	Status	°C	Usage
1	IDE(80.0 GB)	Good	-	Rec. On
2	IDE(80.0 GB)	Good	-	Rec. On
3	IDE(CD-RW)	-	-	Clip Copy
4	IDE(80.0 GB)	Good	-	Rec. On

Storage Problem Action :

Alarm Out / Notify

OK

Figure 29 — Storage screen.

The **Type** field displays the type and capacity of storage devices.

The **Status** field displays the device status or fault conditions. (Good, Disk Bad, S.M.A.R.T. Alert, High Temperature, or Not installed)

NOTE: If the DVR senses *S.M.A.R.T. Alert* or *High Temperature*, the **S.M.A.R.T. Monitoring Information** screen will appear. Once the **S.M.A.R.T. Monitoring Information** screen displays, replacing the hard disk drive is recommended, usually within 24 hours.

NOTE: The **S.M.A.R.T. Monitoring Information** screen appears only in the monitoring mode.

The **°C** field displays the temperature of the storage device.

The **Usage** field displays the device usage.

The DVR can be set to react to storage problems by activating an internal buzzer or external alarms, display the warning message and/or notifying a PC running RAS (Remote Administration System). Highlight the box beside **Storage Problem Action: Alarm Out / Notify** and press the  button to select from Beep, the alarm output terminal that you want to associate with the storage problem event, and/or Notify.

Highlight the **S.M.A.R.T. Setup...** and press the  button. The **S.M.A.R.T. Setup** screen appears.

NOTE: If no hard disk drives are installed on the DVR, the **S.M.A.R.T. Setup...** button will be disabled.

S.M.A.R.T. Setup	
Use	On
Last-check	2004-05-04 01:25:34
Period	Daily
Check Time	03:23:41
Temperature Threshold	60
Sensor Unit	Celsius
	Check Now
OK	Cancel

Figure 30 — S.M.A.R.T. Setup screen.

Your DVR shows the conditions of Hard Disk Drives when the installed IDE hard disk drives support S.M.A.R.T. (Self-Monitoring, Analysis and Reporting Technology) Monitoring program. Highlight the box beside **Use**. Press the  button to toggle between On and Off.

The **Last-check** field shows the date and time information of the last storage check.

Highlight the box beside **Period**, and select from Daily, Weekly or Monthly for the checking period.

NOTE: When selecting *Weekly* and *Monthly*, the *Day of Week* and *Day of Month* field will be activated under the **Period field. Select the check day or check date.**

Highlight the box beside **Check Time**, and adjust the numbers using arrow buttons.

Highlight the box beside **Temperature Threshold** and adjust the numbers using arrow buttons.

Highlight the box beside **Sensor Unit** and select from Celsius or Fahrenheit.



If you want to check the storage status instantly, highlight **Check Now** and press the  button.

You can save your changes by highlighting **OK** and pressing the  button. Selecting **Cancel** exits the screen without saving the changes.

System Log Screen

Highlight **System Log** in the Main menu and press the  button. The **System Log** screen appears.

System Log		
No.	Event	Date/Time
1283	Setup Begin (Local)	2002-01-24 10:27:14
1282	System Started	2002-01-24 10:27:12
1281	Shutdown	2002-01-24 10:27:02
1280	System Time Changed	2002-01-24 10:27:00
1279	Setup Begin (Local)	2002-01-24 10:26:08
1278	System Started	2002-01-24 10:26:02
1277	System Reboot	2002-01-24 10:26:02

1283  

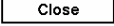





Figure 31 — System Log screen.

The **System Log** screen displays a record of various events logged by the DVR. The list shows the dates and times the system was turned ON and OFF, system was restarted, recording was started or stopped, playback was started or stopped, setup changes were made, and data banks were cleared.

The events are listed from the most recent to the oldest. You can scroll through the list a page at a time by selecting the **Up** and **Down** arrow buttons and pressing the  button. You can go directly to an event number by highlighting the event number box (left of the **UP** arrow), pressing the  button, using the arrow buttons to change the number, and pressing the  button.

System Shutdown

Highlight **System Shutdown** in the Main menu and press the  button. This shuts the DVR down. When shutting down the DVR, you need to confirm that you want to shut down the unit, and you will be asked for an administrator password.

Configuring Input Devices

You can configure the video, audio and remote control devices connected to the DVR.



Figure 32 — Device menu screen.

Camera Setup Screen

Highlight Camera in the Main menu and press the button. The Camera setup screen appears.

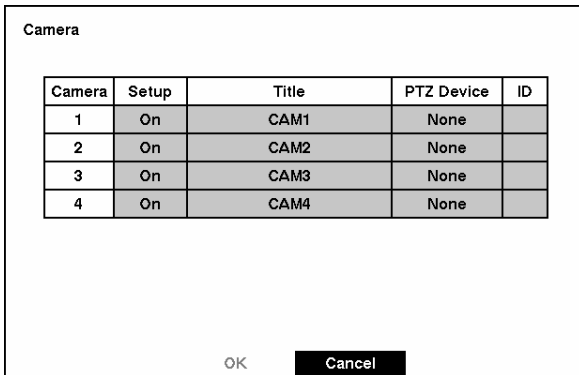



Figure 33 — Camera setup screen.

You can turn on or off each camera, and also hide the video of the camera number by highlighting the camera Setup heading and pressing the button. Select the On, Off, Covert 1 or Covert 2 from a drop down list.

NOTE: When selecting the *Covert 1*, the DVR displays the camera title and status icons on the covert video. When selecting the *Covert 2*, the DVR displays only camera title on the covert video.

You can assign titles to each camera by highlighting the **Title** heading and pressing the  button. A virtual keyboard allows you to enter camera names.

Selecting the **PTZ Device** box causes a list of controllable cameras to display. Select your camera from the list and press the  button. You will need to connect the camera to the RS-485 terminal on the back of the DVR following the camera manufacturer's instructions.

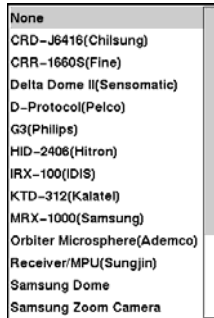



Figure 34 — PTZ Device list.

You can assign IDs to each camera by highlighting the **ID** heading and pressing the  button. Change the number by highlighting it and using the arrow buttons to increase and decrease the number. The PTZ ID number can be set from 0 to 256.

Alarm In Setup Screen

Highlight **Alarm In** in the Main menu and press the  button. The **Alarm In** setup screen appears.

Alarm In

Alarm In	Setup	Title	NC/NO
1	Off		NO
2	Off		NO
3	Off		NO
4	Off		NO

OK
Cancel

Figure 35 — Alarm In setup screen.

The alarm terminal strip on the back of the DVR has inputs associated with each alarm. You can set up each input on the **Alarm In Setup** screen. You can turn each input **On** (via **Alarm I/O** or **Camera Alarm**) or **Off**. Each input can be given a title, and the inputs can be set as **NO** (normally open) or **NC** (normally closed) independently.

Motion Detector

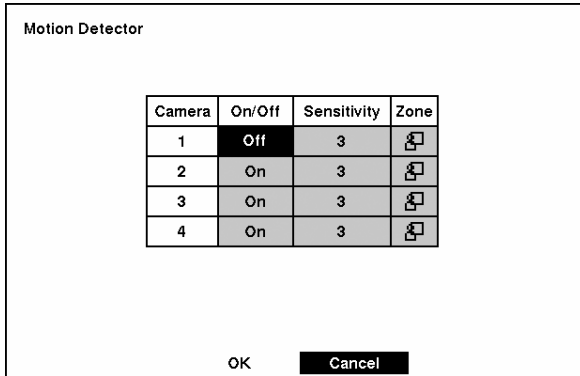

Figure 36 — Motion Detector setup screen.

Your DVR has built-in video motion detector. Video motion detector can be turned On or Off for each camera.

Highlighting the box under the **Sensitivity** heading allows you to adjust the DVR's sensitivity to motion. There are five settings with 1 being the least sensitive and 5 being the most sensitive.

You can define the area of the image where you want to detect motion; e.g., a doorway. Highlight the icon under the **Zone** heading, and press the button. The Motion Detection Zone screen will display.

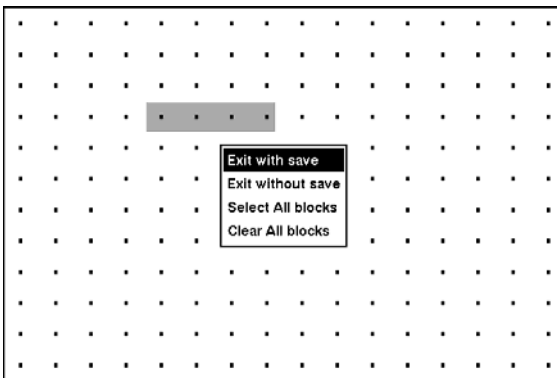



Figure 37 — Motion Detection Zone screen.

The **Motion Detection Zone** screen is laid over the video for the selected camera. You can set up motion detection zones by selecting or clearing blocks. The menu on the setup screen has the following functions:

NOTE: You can activate or deactivate 4 cells at a time using the  button. Once 4 cells are highlight, you can select individual cells by using the camera buttons.

Exit with save — Closes the menu after saving the changes.

Exit without save — Closes the menu without saving the changes.

Select All blocks — Activates all blocks to detect motion.

Clear All blocks — Deactivates all blocks so that they will not detect motion.

Text-In Setup Screen

Highlight Text-In in the Main menu and press the  button. The Text-In setup screen appears.

Text-In

Use Text-In

Multi-devices on 1 channel

No.	On/Off	Product Type	Setup
1	On	Generic Text	<input checked="" type="checkbox"/>
2	Off	Generic Text	<input checked="" type="checkbox"/>
3	Off	Generic Text	<input checked="" type="checkbox"/>
4	Off	Generic Text	<input checked="" type="checkbox"/>

OK Cancel

Figure 38 — Text-In Setup screen.

NOTE: If networking is configured by the external modem, the text-in cannot be set up. Set the DVR for LAN connections and set up text-in for RS-232C port.

NOTE: Text-in data will not be recorded during clip copy.

You can set the DVR to display the text-in information. Highlight the box beside Use Text-In and press the  button to toggle between On and Off.

Highlight the box beside Product Type, and press the  button. Select your device from the list.

NOTE: Generic Text and E-POS devices are currently supported.

Highlight the Multi-devices on 1 channel box and press the button to toggle between On and Off. When it is On, the DVR supports up to 4 text inputs.

NOTE: The following description is for a Generic Text device. The screen changes for different types of text input devices, and there will be different parameter boxes for you to enter information.

Text-In 1: Generic Text

Transaction Start	<input type="text"/>	<input type="checkbox"/> Any Character
Transaction End	<input type="text"/>	0 more line(s)
Line Delimiter	<input type="text" value="^M^J"/>	
Ignore String	<input type="text"/>	
Transaction Timeout	<input type="text" value="10"/>	
Display Dwell	<input type="text" value="10"/>	
	<input type="checkbox"/> Case Sensitive	

OK

Figure 39 — Text-In (Generic Text) Setup screen.

Highlight the box beside **Transaction Start**, and press the button. Use the virtual keyboard to enter the Transaction Start string. Refer to the device manufacturer's documentation for the text string that the device first sends when a transaction starts.

If you want the DVR to react to any character sent from the text input device, you will want to turn **On Any Character**. Highlight **Any Character**, and press the button to toggle between On and Off.

NOTE: If *Any Character* is turned On, you will not be able to enter any text in the Start String box.

Highlight the box beside **Transaction End**, and press the button. Use the virtual keyboard to enter the Transaction End string. Refer to the device manufacturer's documentation for the text string that the device sends when a transaction ends.

Highlight the **more line(s)** box and press the button. Select the number of additional lines of text that you want the DVR to record. You can choose from 0 to 10.

Highlight the box beside **Line Delimiter**, and press the button. Use the virtual keyboard to enter the character(s) that the device uses to indicate the end of a line. Control characters can be created using ^ and a capital letter; e.g., ^J for NL (New Line), ^M for CR (Carriage Return). Refer to the device manufacturer's documentation for Line Delimiter character(s).

Highlight the box beside **Ignore String**, and press the button. Use the virtual keyboard to enter the any strings of text that you want the DVR to ignore. Refer to the device manufacturer's documentation for text strings that the device sends during transactions, so you will know which ones you do not want recorded.

Highlight the box beside **Transaction Timeout**, and set the length of time to wait for the new text string. The DVR will consider a transaction ends if there is no text sting during timeout dwell after the last text input string. You can adjust the timeout dwell from 0 to 300 seconds.

Highlight the box beside **Display Dwell**, and set the length of time you would like to display text-in data. You can adjust the display dwell time from 1 to 300 seconds.

Highlight the **Case Sensitive** box and press the button to toggle between On and Off. Refer to the device manufacturer's documentation to determine if the text strings are Case Sensitive. If the device distinguishes between upper and lower case letters, make certain the **Case Sensitive** box is turned On.

Highlight the box beside **Description** and press the button. A virtual keyboard displays. Enter the name for the text-in device.

Highlight the box beside **keyword 1** and press the button to display a virtual keyboard. Enter the first keyword for transaction field detection. The keyword identifies any word after itself as a transaction field, and reports the text-in information in the event log.

NOTE: The following description is for an E-POS device.

Text-In 1: E-POS	
Register Number	<input type="text" value="00"/>
C/J Prefix	<input type="text" value="C"/>
Transaction Start	<input type="text"/> <input type="checkbox"/> Any Character
Transaction End	<input type="text"/> 0 more line(s)
Line Delimiter	<input type="text" value="^M^J"/>
Ignore String	<input type="text"/>
Transaction Timeout	<input type="text" value="10"/>
Display Dwell	<input type="text" value="10"/>
	<input type="checkbox"/> Case Sensitive
<input type="button" value="OK"/> <input type="button" value="Cancel"/>	

Figure 40 — Text-In (E-POS) Setup screen.

Highlight the box beside **Register Number** and press the button. Change the number by highlighting it and using the Up and Down arrow buttons to increase or decrease the number. The Register Number is used to identify any specific text input when the E-POS device has multi text inputs.

Highlight the box beside **C/J Prefix** and press the button to toggle between C (Customer data) and J (Journal data).

NOTE: The settings from *Transaction Start* to *Case Sensitive* are identical to Generic Text settings.

Alarm Out Setup Screen

The Alarm Out setup screen allows you to establish a schedule for each alarm output from the DVR.

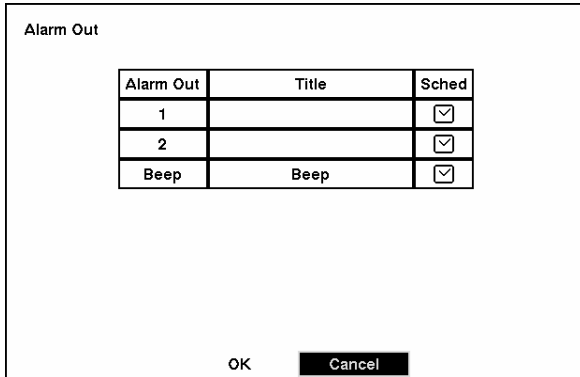

Figure 41 — Alarm Out setup screen.

Each alarm output can be given its own title by highlighting the box under the Title heading and pressing the button. A virtual keyboard appears allowing you to enter the title.

Highlighting the Sched field and pressing the button opens a schedule screen. You can schedule alarm output in 30-minute increments from 0:00 to 24:00.

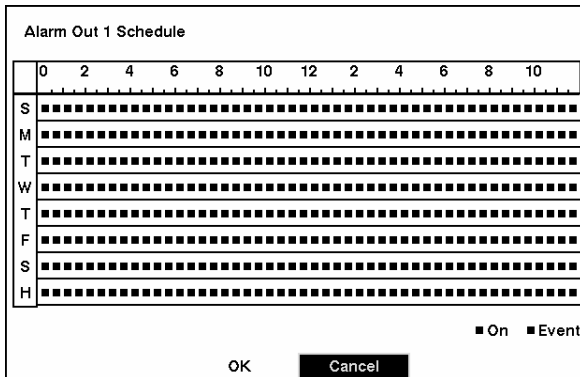

Figure 42 — Alarm Out Schedule screen.

You can select individual blocks of time, entire days of the week, entire blocks of time or the entire schedule. Select a specific block of time by highlighting it. Select an entire day by highlighting the day of the week or Holiday on the left of the screen. Select an entire block of time by highlighting the time at the top of the screen. Select the entire screen by highlighting the empty box in the upper left corner of the screen. Press the button from No Arming (no block) to On (blue block) to Event (yellow block).

When set to **On**, the Alarm Out is active during the scheduled time. When set to **Event**, the Alarm Out is only active when there is an Event during the scheduled time.

Audio Setup Screen

Highlight **Audio** in the Main menu and press the **←** button. The **Audio Setup** screen appears.

The screenshot shows the 'Audio Setup' screen with the following elements:

- Audio Recording**: A box containing the text 'Off'.
- Mute**: A box containing the text 'Off'.
- Audio In**: A table with the following data:

Audio	On/Off
1	On
2	On
3	On
4	On
- At the bottom of the screen are two buttons: **OK** and **Cancel**.

Figure 43 — Audio Setup screen.

Highlight the box beside **Audio Recording** and press the **←** button. This toggles between **On** and **Off**. When it is **On**, the DVR also records audio when it is recording video.

Highlight the box beside **Mute** and press the **←** button. This toggles between **On** and **Off**. When it is **On**, the DVR will **NOT** play live or recorded audio.

The DVR supports 4 Audio inputs. You can set up each input on the Audio Setup screen. When it is **On**, the DVR will play live audio through the attached speaker when it displays live video. Move to the **Audio In** field, and highlight the box under **On/Off** heading, and press the **←** button. This toggles between **On** and **Off**.

You can save your changes by highlighting **OK** and pressing the **←** button. Selecting **Cancel** exits the screen without saving the changes.

NOTE: The DVR will **NOT** record audio when the recording speed is set to less **15 ips (12.5 ips for PAL)**. The DVR may not record audio depending on the **Transfer Speed** when the **RAS (Remote Administration System) Watch** application program is connected.

RS232/RS485 Setup Screen

The RS232/RS485 setup screen allows you to set up the RS-232C and RS-485 ports to communicate with external devices such as remote controls and dome cameras.

RS232/RS485

RS232/RS485	RS232	RS485
Baud Rate	9600	57600
Parity	None	None
Data Bit	8	8
Stop Bit	1	1
Usage	Text-In	Remote Control

Figure 44 — RS232/RS485 setup screen.

Highlight the field for the settings you wish to make. Select the correct Baud Rate, Parity, Data Bit and Stop Bit for the device you are connecting to the DVR.

For RS232, it is possible to select Remote Control, External Modem or Text-In in the Usage field. For RS485, it is possible to select either Remote Control or PTZ Control in the Usage field.

NOTE: Selecting the *External Modem* in the *RS232* field only defines the RS-232C port as being used for the external modem connections. Refer to *Modem Setup* screen for details of setting up an external modem.

NOTE: Selecting the *PTZ Control* in the *RS485* field only defines the RS-485 port as being used for the PTZ camera connections. Select the PTZ device in the *Camera Setup* screen.

NOTE: If networking is configured by the external modem, Text-In cannot be set for the *RS232* field. In the *Network Setup* menu, set up the DVR for LAN connections first.

Configuring Recording Settings

NOTE: When the DVR is recording video, the REC LED on the front panel is lit and a red dot appears on the monitor.

Your DVR offers a variety of flexible recording modes. You can set it up to record all the time or to only record events. It can be set up to continue recording once the hard disk drive is full by recording over the oldest video, or you can set it up to alert you when the hard disk is full and stop recording.

Record Mode Setup Screen

Record Mode Setup	
Resolution	Standard
End Of Disk	Stop
On Disk Full Beep	Off
On Disk Full Alarm Out	Off
On Panic Recording Speed	30.0 ips
On Panic Recording Quality	Very High
Time-Lapse Recording	On
Auto Deletion	Off 1 Day
OK	Cancel

Figure 45 — Record Mode Setup screen.

Highlight the box beside Resolution and press the button. This toggles between Standard and High.

NOTE: The maximum recording speed is 30 images per second (25 ips for PAL) when the resolution is set to *Standard*. However, when set to *High*, the recording speed will be decreased to 15 images per second (12.5 ips for PAL).

Highlight the box beside End Of Disk and press the button. This toggles between Overwrite and Stop. When in the Overwrite mode, the DVR continues recording when the hard disk drive is full by overwriting the oldest video. When in the Stop mode, the DVR stops recording when the hard disk drive is full.

If the DVR is set to the Stop mode, you can set it to beep or activate the Alarm Out port when the hard disk drive is full. Highlight the box beside On Disk Full Beep and press the button to toggle between On and Off. Highlight the box beside On Disk Full Alarm Out and press the button to toggle between On and Off.

Pressing the **PANIC** button on the front panel enters the Panic Recording mode. You can program the recording speed and quality when the DVR is in the Panic Recording mode. On Panic Recording Speed can be set from 0.5 to 30 ips (25 ips PAL), and On Panic Recording Quality can be selectable from Very High, High, Standard and Low. Press the **PANIC** button again to release the panic recording mode.

NOTE: When the DVR is in the Panic Recording mode, it ignores the time-lapse or event recording settings and follows the panic recording settings.

NOTE: The maximum panic recording speed is 30 images per second (25 ips for PAL) when the resolution is set to *Standard*. However, when set to *High*, the recording speed will be decreased to 15 images per second (12.5 ips for PAL).

NOTE: When the DVR is recording video, a red dot appears on the screen. When the DVR is in the Panic Recording mode, a white ! appears in the red dot, and the REC LED on the front panel flickers.

You can set the DVR to record video based on Time-lapse Recording Schedule defined during Time-Lapse Record Setup. Highlight the box beside Time Lapse Recording and press the **←** button toggles between On and Off.

Highlight the first box beside Auto Deletion. Pressing the **←** button toggles between On and Off. When set to On, the DVR will delete video recorded earlier than user-defined period. Highlight the second box beside Auto Deletion, and press the **←** button to select the length of time recorded data will be kept from 1 to 99 Days.

NOTE: When the *End Of Disk* is set to *Stop*, DVR will NOT restart recording even when the video recorded earlier than user-defined period is deleted.

You can save your changes by highlighting OK and pressing the **←** button. Selecting Cancel exits the screen without saving the changes.

Time-Lapse Record Mode Setup Screen

Time-Lapse Record Setup

Camera	Sched	Mode 1		Mode 2	
		Speed	Quality	Speed	Quality
1	<input checked="" type="checkbox"/>	1 ips	Standard	1 ips	Standard
2	<input checked="" type="checkbox"/>	1 ips	Standard	1 ips	Standard
3	<input checked="" type="checkbox"/>	1 ips	Standard	1 ips	Standard
4	<input checked="" type="checkbox"/>	1 ips	Standard	1 ips	Standard

Keep the continuous pictures

Figure 46 — Time-Lapse Record Setup screen.

Highlight the box under the **Speed** heading and press the  button. A drop-down list of recording speeds appears. You can select from 0.5 ips to 30 ips (25 ips for PAL).

NOTE: You cannot select 30 ips (25 ips for PAL) for High Resolution.

Highlight the box under the **Quality** heading and press the  button. A drop-down list appears. You can select from **Very High**, **High**, **Standard** and **Low** image quality. All other variables being equal; **Very High** will require 300% more hard disk space than **Standard**, **High** will require 200% more, and **Low** 50% less.

NOTE: Higher quality images require more storage space and will reduce the recording capacity of the hard disk drive.

You can set the maximum amount of time-lapse video to be stored. Once the DVR reaches this amount, it will start recording over the oldest time-lapse video. The time-lapse video is stored separate from Event video. When **Keep the continuous pictures** is set to **On**, you can set the time from 1 Hour to the maximum allowed by the storage capacity of your hard disk drive.

NOTE: The maximum storage time is only an estimate because the amount of space required to store video varies depending on many factors such as motion and image complexity.

Time-Lapse Recording Schedule

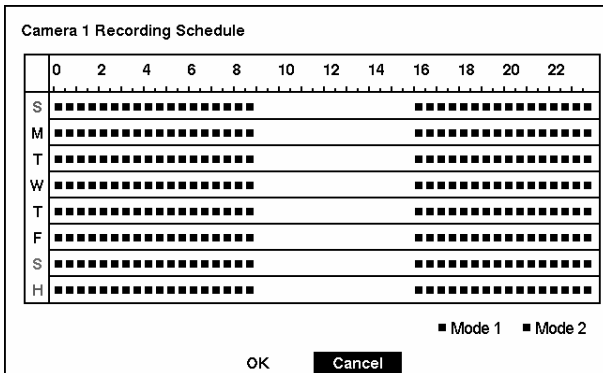







Figure 47 — Time-Lapse Recording Schedule screen.

You can program the DVR to record only during certain times based on time, day of the week, and holidays. The smallest time segment you can use is 30 minutes. A blue rectangle indicates the DVR is set to record during those 30 minutes. When there is no rectangle, the DVR will not record during those 30 minutes.

There are several ways to set recording times:

- You can highlight an individual block and toggle it On or Off by pressing the  button.
- You can change a 30-minute segment for all days by placing the cursor on the time line and pressing the  button to toggle the segment On or Off.
- You can change an entire day by placing the cursor on the day of the week and pressing the  button to toggle the day On or Off.
- You can change the entire calendar by placing the cursor in the upper left-hand box (above “S” and to the left of the time line) and pressing the  button to toggle the entire calendar On and Off.

NOTE: The Holiday (H) schedule applies to the dates you established as holidays when setting Date/Time.

You can save your changes by highlighting OK and pressing the  button. Selecting Cancel exits the screen without saving the changes.

Pre-Event Recording Setup Screen

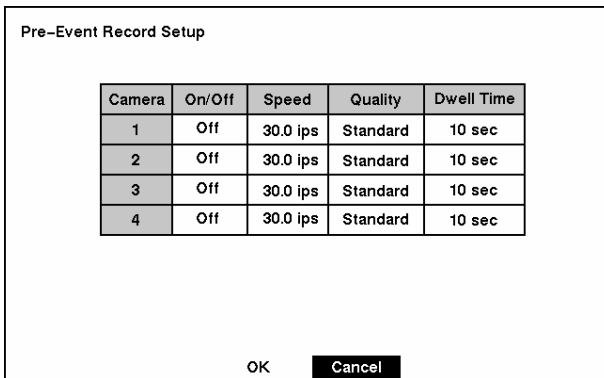

Figure 48 — Pre-Event Record Setup screen.

When the DVR is in the Event Record mode, it is possible to have it record images before the event occurs. The Pre-Event Record screen allows you to define how to handle pre-event recording.

You can turn individual cameras On or Off for pre-event recording. The image speed can be set from 0.5 to 30 ips (25 ips PAL), and image quality can be selectable from High, Standard and Low.

NOTE: The pre-event recording speed is 30 images per second (25 ips for PAL) when the resolution is set to Standard. However, when set to High, the recording speed will be decreased to 15 images per second (12.5 ips for PAL).

You can set the amount of time to record prior to the event by adjusting the Dwell Time. You can set the Dwell Time from 1 to 300 seconds.

NOTE: When the DVR is in the Time-Lapse mode, it ignores the pre-event settings and follows the time-lapse settings.

Event Action Setup

You can program the DVR to record, activate the alarm output and/or notify the remote site whenever sensor, motion, text-in or video loss events are detected. Highlight the Alarm-In Action, Motion Action, Text-In Action or Video Loss Action in the Event Action menu and press the  button. The Event Action setup screens will appear.

Alarm In Event Action (Record) Setup Screen

The DVR can be set to react to events differently. Each sensor can be assigned a schedule, camera, recording speed, video quality and dwell time.

Alarm In Event Action					
		Mode 1	Mode 2		
		Record	Alarm Out	Notify	
Sensor	Sched	Camera	Speed	Quality	Dwell Time
1	<input checked="" type="checkbox"/>	1	30.0 ips	Standard	10 sec
2	<input checked="" type="checkbox"/>	2	30.0 ips	Standard	10 sec
3	<input checked="" type="checkbox"/>	3	30.0 ips	Standard	10 sec
4	<input checked="" type="checkbox"/>	4	30.0 ips	Standard	10 sec

OK Cancel

Figure 49 — Alarm In Event Action (Record) setup screen.

Highlight the Sched box and press the  button. A schedule screen appears. Set the schedule as described earlier.

Highlight the Camera box and press the  button. A camera selection screen appears. Select the camera number you would like to associate with the sensor.

NOTE: You can associate multiple cameras with a sensor.

Highlight the Speed box and select number of images per second you would like to record from the drop-down menu.

Highlight the Quality box and select the image quality you want to record from the drop-down menu.

Highlight the Dwell Time box and set the length of time you would like to record for the associated event.

Alarm In Event Action (Alarm Out) Setup Screen

The DVR can be set to react to events differently by activating an internal buzzer or external alarms.

Alarm In Event Action

		Mode 1	Mode 2
		Record	Alarm Out
		Notify	
Sensor	Sched	Alarm Out	Dwell Time
1	<input checked="" type="checkbox"/>	-	10 sec
2	<input checked="" type="checkbox"/>	-	10 sec
3	<input checked="" type="checkbox"/>	-	10 sec
4	<input checked="" type="checkbox"/>	-	10 sec

OK **Cancel**

Figure 50 — Alarm In Event Action (Alarm Out) setup screen.

Highlight the Sched box and press the button. A schedule screen appears. Set the schedule as described earlier.

Highlight the Alarm Out box and select either Beep or the alarm output terminal that you want to associate with the sensor.

Highlight the Dwell Time box and set the length of time you want the output activated.

Alarm In Event Action (Notify) Setup Screen

The DVR can be set to notify the remote site when certain events are activated.

Alarm In Event Action

		Mode 1	Mode 2
		Record	Alarm Out
		Notify	
Sensor	Sched	Notify	
1	<input checked="" type="checkbox"/>	Off	
2	<input checked="" type="checkbox"/>	Off	
3	<input checked="" type="checkbox"/>	Off	
4	<input checked="" type="checkbox"/>	Off	

OK **Cancel**

Figure 51 — Alarm In Event Action (Notify) setup screen.

Highlight the **Sched** box and press the button. A schedule screen appears. Set the schedule as described earlier.

Highlight the **Notify** box and press the button. This toggles between **On** and **Off**. When it is **On**, the DVR notifies the remote site when certain events occur based on a defined schedule.

NOTE: For the Notify action, the DVR should be registered in the RAS (Remote Administration System).

Motion Detector Event Action (Record) Setup Screen

The DVR can be set to react to motion detector differently. Each camera can be assigned a schedule, associated camera, recording speed, video quality and dwell time.

Motion Detector Event Action					
		Mode 1	Mode 2		
		Record	Alarm Out	Notify	
Camera	Sched	Camera	Speed	Quality	Dwell Time
1	<input checked="" type="checkbox"/>	1	30.0 ips	Standard	10 sec
2	<input checked="" type="checkbox"/>	2	30.0 ips	Standard	10 sec
3	<input checked="" type="checkbox"/>	3	30.0 ips	Standard	10 sec
4	<input checked="" type="checkbox"/>	4	30.0 ips	Standard	10 sec

OK

Figure 52 — Motion Detector Event Action (Record) setup screen.

Highlight the **Sched** box and press the button. A schedule screen appears. Set the schedule as described earlier.

Highlight the **Camera** box and press the button. A camera selection screen appears. Select the camera number you would like to associate with the camera.

NOTE: You can associate multiple cameras with a camera that detects motion.

Highlight the **Speed** box and select number of images per second you would like to record from the drop-down menu.

Highlight the **Quality** box and select the image quality you want to record from the drop-down menu.

Highlight the **Dwell Time** box and set the length of time you would like to record for the associated motion event.

Motion Detector Event Action (Alarm Out) Setup Screen

The DVR can be set to react to motion events differently by activating an internal buzzer or external alarms.

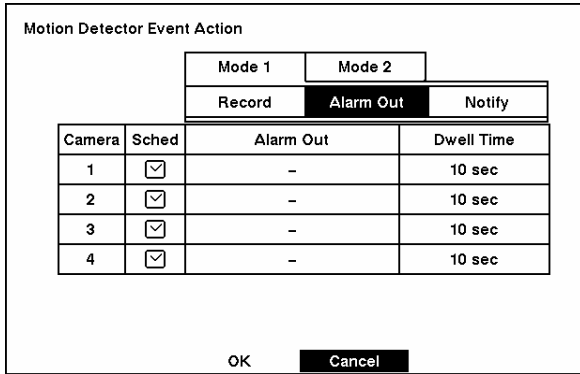



Figure 53 — Motion Detector Event Action (Alarm Out) setup screen.

Highlight the Sched box and press the  button. A schedule screen appears. Set the schedule as described earlier.

Highlight the Alarm Out box and either Beep or the alarm output terminal that you want to associate with the motion event.

Highlight the Dwell Time box and set the length of time you want the output activated.

Motion Detector Event Action (Notify) Setup Screen

The DVR can be set to notify the remote site when certain motion events are activated.

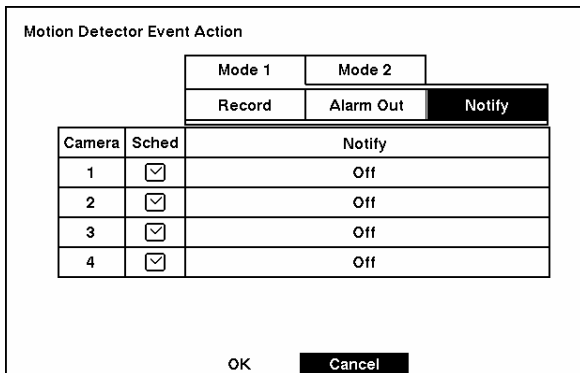



Figure 54 — Motion Detector Event Action (Notify) setup screen.

Highlight the **Sched** box and press the  button. A schedule screen appears. Set the schedule as described earlier.

Highlight the **Notify** box and press the  button. This toggles between **On** and **Off**. When it is **On**, the DVR notifies the remote site when certain events occur based on a defined schedule.

NOTE: For the Notify action, the DVR should be registered in the RAS (Remote Administration System).

Text-In Event Action (Record) Setup Screen

The DVR can be set to react to text input from the Text-in device. The text-in can be assigned a schedule, associated camera, recording speed, video quality and dwell time.

Text-In Event Action					
		Mode 1	Mode 2		
		Record	Alarm Out	Notify	
Text-In	Sched	Camera	Speed	Quality	Dwell Time
1	<input checked="" type="checkbox"/>	1	30.0 ips	Standard	10 sec
2	<input checked="" type="checkbox"/>	2	30.0 ips	Standard	10 sec
3	<input checked="" type="checkbox"/>	3	30.0 ips	Standard	10 sec
4	<input checked="" type="checkbox"/>	4	30.0 ips	Standard	10 sec

OK Cancel

Figure 55 — Text-In Event Action (Record) setup screen.

Highlight the **Sched** box and press the  button. A schedule screen appears. Set the schedule as described earlier.

Highlight the **Camera** box and press the  button. A camera selection screen appears. Select the camera number you would like to associate with the text-in device.

NOTE: You cannot associate multiple cameras with a text-in device.

Highlight the **Speed** box and select number of images per second you would like to record from the drop-down menu.

Highlight the **Quality** box and select the image quality you want to record from the drop-down menu.

Highlight the **Dwell Time** box and set the length of time you would like to record for the text input.

Text-In Event Action (Alarm Out) Setup Screen

The DVR can be set to react to text-in by activating an internal buzzer or external alarms.

Text-In Event Action

		Mode 1	Mode 2	
		Record	Alarm Out	Notify

Text-In	Sched	Alarm Out	Dwell Time
1	<input checked="" type="checkbox"/>	-	10 sec
2	<input checked="" type="checkbox"/>	-	10 sec
3	<input checked="" type="checkbox"/>	-	10 sec
4	<input checked="" type="checkbox"/>	-	10 sec

OK Cancel

Figure 56 — Text-In Event Action (Alarm Out) setup screen.

Highlight the Sched box and press the  button. A schedule screen appears. Set the schedule as described earlier.

Highlight the Alarm Out box and either Beep or the alarm output terminal that you want to associate with the text-in device.

Highlight the Dwell Time box and set the length of time you want the output activated.

Text-In Event Action (Notify) Setup Screen

The DVR can be set to notify the remote site in the case of text-in.

Text-In Event Action

		Mode 1	Mode 2	
		Record	Alarm Out	Notify

Text-In	Sched	Notify
1	<input checked="" type="checkbox"/>	Off
2	<input checked="" type="checkbox"/>	Off
3	<input checked="" type="checkbox"/>	Off
4	<input checked="" type="checkbox"/>	Off

OK Cancel

Figure 57 — Text-In Event Action (Notify) setup screen.

Highlight the **Sched** box and press the button. A schedule screen appears. Set the schedule as described earlier.

Highlight the **Notify** box and press the button. This toggles between On and Off. When it is On, the DVR notifies the remote site when it has text input from a text-in device based on a defined schedule.

NOTE: For the Notify action, the DVR should be registered in the RAS (Remote Administration System).

Video Loss Event Action (Record) Setup Screen

The DVR can be set to react to video loss from a camera differently. Each camera can be assigned a schedule, associated camera, recording speed, video quality and dwell time.

Video Loss Event Action					
		Mode 1	Mode 2		
		Record	Alarm Out	Notify	
Camera	Sched	Camera	Speed	Quality	Dwell Time
1	<input checked="" type="checkbox"/>	-	30.0 ips	Standard	10 sec
2	<input checked="" type="checkbox"/>	-	30.0 ips	Standard	10 sec
3	<input checked="" type="checkbox"/>	-	30.0 ips	Standard	10 sec
4	<input checked="" type="checkbox"/>	-	30.0 ips	Standard	10 sec

OK

Figure 58 — Video Loss Event Action (Record) setup screen.

Highlight the **Sched** box and press the button. A schedule screen appears. Set the schedule as described earlier.

Highlight the **Camera** box and press the button. A camera selection screen appears. Select the camera number you would like to associate with the camera that has lost video.

NOTE: You can associate multiple cameras with a camera.

Highlight the **Speed** box and select number of images per second you would like to record from the drop-down menu.

Highlight the **Quality** box and select the image quality you want to record from the drop-down menu.

Highlight the **Dwell Time** box and set the length of time you would like to record for the associated video loss.

Video Loss Event Action (Alarm Out) Setup Screen

The DVR can be set to react to video loss differently by activating an internal buzzer or external alarms.

Video Loss Event Action

		Mode 1	Mode 2
		Record	Alarm Out
Camera	Sched	Alarm Out	
1	<input checked="" type="checkbox"/>	Beep	
2	<input checked="" type="checkbox"/>	Beep	
3	<input checked="" type="checkbox"/>	Beep	
4	<input checked="" type="checkbox"/>	Beep	

OK Cancel

Figure 59 — Video Loss Event Action (Alarm Out) setup screen.

Highlight the Sched box and press the button. A schedule screen appears. Set the schedule as described earlier.

Highlight the Alarm Out box and either Beep or the alarm output terminal that you want to associate with the camera that has lost video.

Video Loss Event Action (Notify) Setup Screen

The DVR can be set to notify the remote site in the case of video loss.

Video Loss Event Action

		Mode 1	Mode 2
		Record	Alarm Out
Camera	Sched	Notify	
1	<input checked="" type="checkbox"/>	Off	
2	<input checked="" type="checkbox"/>	Off	
3	<input checked="" type="checkbox"/>	Off	
4	<input checked="" type="checkbox"/>	Off	

OK Cancel

Figure 60 — Video Loss Event Action (Notify) setup screen.

Highlight the **Sched** box and press the button. A schedule screen appears. Set the schedule as described earlier.

Highlight the **Notify** box and press the button. This toggles between **On** and **Off**. When it is **On**, the DVR notifies the remote site when it loses video input from a camera based on a defined schedule.

NOTE: For the Notify action, the DVR should be registered in the RAS (Remote Administration System).

Display Setup

Highlight the **OSD, Main Monitoring** in the **Main** menu, and press the button to set up the on-screen display or camera display on the main monitor.

OSD (On-Screen Display) Setup

The DVR can be set up to display **Date**, **Time**, **Title** and **Status** on screen. Each feature can be turned on or off, and you can adjust the margins.

The screenshot shows the 'OSD Setup' dialog box with the following settings:

Date	<input type="checkbox"/> On
Time	<input type="checkbox"/> On
Title	<input type="checkbox"/> On
Status	<input type="checkbox"/> On
Left/Right Margin	<input type="text" value="24"/>
Top/Bottom Margin	<input type="text" value="10"/>
Text-In	<input type="checkbox"/> On
Text-In Background color	<input type="checkbox"/> On

At the bottom of the dialog are two buttons: **OK** and **Cancel**.

Figure 61 — OSD Setup screen.

Highlight the box beside **Date** and press the button to toggle the date display **On** and **Off**.

Highlight the box beside **Time** and press the button to toggle the time display **On** and **Off**.

Highlight the box beside **Title** and press the button to toggle the camera title display **On** and **Off**.

Highlight the box beside **Status** and press the button to toggle status display **On** and **Off**.

Highlight the box beside **Left/Right Margin** and press the button to adjust the left and right margins. The margins can be set from 1 to 24.

Highlight the box beside **Top/Bottom Margin** and press the button to adjust the top and bottom margins. The margins can be set from 1 to 24.

Highlight the box beside **Text-In** and press the button to toggle the text-in data display **On** and **Off**.

If you want to read text input strings displayed on the screen easily and clearly, turn **On Text-In Background color**. Highlight the box beside **Text-In Background color** and press the button to toggle between **On** and **Off**.

Main Monitoring Setup Screen

You can adjust the display dwell time for each camera displayed on the main monitor. You also can set the video from the event-detected camera to be displayed on the main monitor during the preset dwell time.

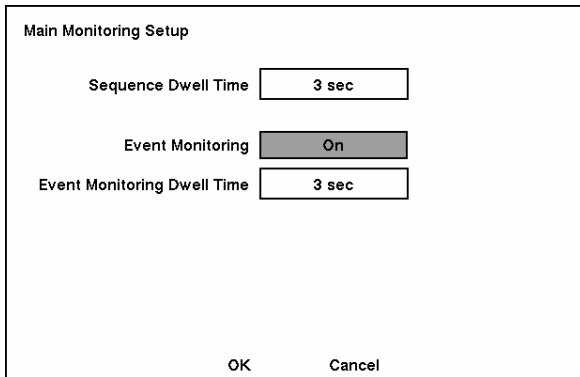

Figure 62 — Main Monitoring Setup screen.

Highlight the box beside **Sequence Dwell Time** and press the button. You can adjust the sequence dwell time from 3 to 60 seconds.

NOTE: The DVR does not sequence the camera having video loss.

Highlight the box beside **Event Monitoring** and press the button to toggle between **On** and **Off**. When it is **On**, video from the lowest camera number among those connected with the event-detected sensor will be displayed full-screen on the main monitor for the preset dwell time.

Highlight the box beside **Event Monitoring Dwell Time** and press the button. You can adjust the event monitoring dwell time from 3 to 60 seconds.

Network Setup Screen

In the Network Setup screen you can set up the DVR for LAN and modem connections.

Connection	LAN	Setup...
Admin Password	*****	
User Password	*****	
Transfer Speed	7	(ips / Camera)
Remote Quality	Standard	

OK **Cancel**

Figure 63 — Network Setup screen.

Highlight the box beside **Connection**. Press the button to toggle between LAN and Modem.

Highlight the box beside **Admin Password** and press the button. A virtual keyboard appears. You will first be asked to enter the current password. Then you can enter a new password; you will be asked to confirm the new password before it is accepted.

Highlight the box beside **User Password** and press the button. A virtual keyboard appears. You will first be asked to enter the current password. Then you can enter a new password; you will be asked to confirm the new password before it is accepted.

NOTE: These passwords are for network use. They are different from the Admin and User passwords for the DVR itself.

NOTE: The passwords are case sensitive. The factory default password for both Administrator and User is *12345678*.

CAUTION: Write the password down and keep it in a safe place. Once the password has been reset, the default will no longer work. If the password is forgotten, the unit must be reset using the *Factory Reset Button* and all data settings will be lost.

The transfer speed indicates image rate transferred to each RAS. Highlight the box beside **Transfer Speed**, press the button, and adjust the number.

NOTE: The maximum transfer speed over a LAN is 30 images per second (25 ips for PAL) when the resolution is set to *Standard*. However, when set to *High*, the transfer speed will be decreased to 15 images per second (12.5 ips for PAL).

You can program the image quality for transferring to the RAS (Remote Administration System). Highlight the box beside **Remote Quality** and press the button. The image quality can be selectable from Very High, High, Standard and Low.

LAN Setup Screen

The screenshot shows a window titled "LAN Setup" with the following fields and buttons:

Type	Manual
IP Address	192.168.1.129
Gateway	192.168.1.254
Subnet Mask	255.255.255.0
DNS Server	
Port Number Setup...	
OK	Cancel

Figure 64— LAN (Manual) Setup screen.

Highlight the box beside **Type** and press button to select from Manual, DHCP and ADSL (PPPoE).

Selecting **Manual** from the **Type** allows you to set up LAN parameters manually.

NOTE: You will need to get the appropriate **IP Address, Gateway and Subnet Mask** from your network administrator.

Change the numbers by highlighting them and using the **Up** and **Down** arrow buttons to increase or decrease the number.

The factory default LAN settings are:

IP Address:	192.168.1.129
Gateway:	192.168.1.254
Subnet Mask:	255.255.255.0

Highlight the box beside **DNS Server** and press button to enter the IP address of the DNS server. If you set up the DNS Server, the domain name of the DVRNS server instead of the IP address can be used during the DVRNS Server setup. Refer to the *DVRNS Setup* section for details.

Highlight **Port Number Setup...** press button. The **Port Number Setup** screen appears.

Port Number Setup	
Remote Admin	8200
Remote Watch	8016
Remote Search	10019
Remote Callback	8201
OK	Cancel

Figure 65 — Port Number Setup screen.

NOTE: You will need to get the appropriate Port Number for each RAS related program (Admin, Watch, Search and Callback) from your network administrator.

Change the number by highlighting it and using the Up and Down arrow buttons to increase or decrease the number.

The factory default Port settings are:

Remote Admin:	8200
Remote Watch:	8016
Remote Search:	10019
Remote Callback:	8201

NOTE: The system restarts automatically after changing the port settings.

NOTE: Do NOT use the same port number for two different programs, otherwise, the DVR cannot be connected with a PC running RAS.

CAUTION: When changing the port settings, you must change the port settings on a PC running RAS as well. Refer to the RAS manual for details.

You can save your changes and return to the Network Setup screen by highlighting OK and pressing the  button. Selecting Cancel exits the screen without saving the changes.

Selecting DHCP from the Type and highlighting OK receives the current IP Address of the DVR configured by DHCP (Dynamic Host Configuration Protocol) network.

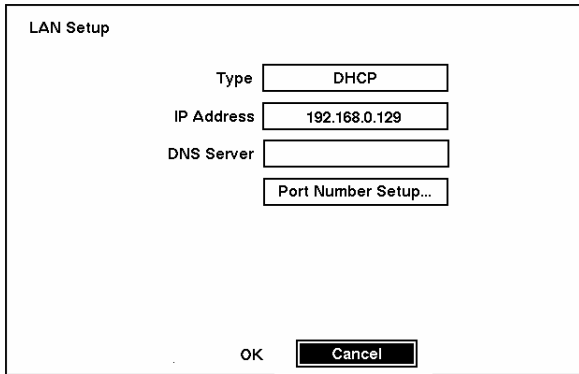

Figure 66 — LAN (DHCP) Setup screen.

Selecting ADSL (PPPoE) allows you to set up the ADSL network.

NOTE: The ADSL and modem cannot be configured at the same time. If the DVR is networked via modem, the ADSL (PPPoE) will not be selected.

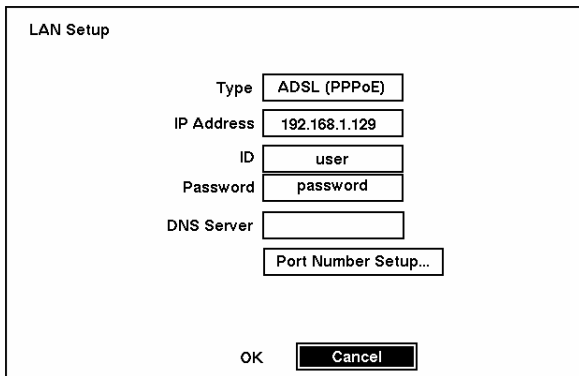



Figure 67 — LAN (ADSL) Setup screen.

Highlight the box beside ID and press  button. A virtual keyboard appears allowing you to enter the ID for ADSL connection.

Highlight the box beside Password and press  button. A virtual keyboard appears allowing you to enter the password for ADSL connection.

NOTE: Entering the ID and Password and highlighting OK receives the current IP Address of the DVR configured by ADSL network.

NOTE: If the DVR is configured by DHCP or ADSL network, the IP address of the DVR might change whenever the unit is turned on.

Modem Setup

The image shows a 'Modem Setup' screen with the following fields and options:

Use	External Modem
Baud Rate	57600
Data Bit	8
Stop Bit	1
Parity	None

At the bottom of the screen, there are two buttons: 'OK' and 'Cancel'.

Figure 68 — Modem Setup screen.

The **Use** field displays the available modem type, **External Modem**.

Highlight the box beside **Baud Rate** and press the  button. A list of baud rates ranging from 300 to 115,200 appears.

Highlight the box beside **Data Bit** and press the  button. This toggles between 7 bit and 8 bit formats.

Highlight the box beside **Stop Bit** and press the  button. This toggles between 1 and 2 Stop Bits.

Highlight the box beside **Parity** and press the  button. A drop-down list appears. You can select from **None**, **Odd** or **Even** parity.

You can save your changes by highlighting **OK** and pressing the  button. Selecting **Cancel** exits the screen without saving the changes.

DVRNS (DVR Name Service) Setup Screen

You can register the DVR on the DVRNS server to use DVR name service.

DVRNS Setup

Use DVR Name Service

DVRNS Server

Port (10000 ~ 12000)

Use NAT

DVR Name

Help desk

Figure 69 — DVRNS Setup screen.

Highlight the box beside Use DVR Name Service and press the button to toggle between On and Off.

Highlight the box beside DVRNS Server and enter the IP address or domain name of the DVRNS server.

NOTE: You will need to get the IP Address or domain name of the DVRNS Server from your network administrator.

NOTE: You can use the domain name instead of IP address if you already set up the DNS Server during the LAN Setup.

Highlight the box beside Port and enter the port number of the DVRNS server. The port number can be set from 10000 to 12000.

NOTE: The DVRNS server settings on your DVR should match the settings on the registered DVRNS server. Any changes on the DVRNS server might cause improper operation.

Highlight the Use NAT box and press the button to toggle On and Off.

NOTE: When using the NAT (Network Address Translation) device, refer to the NAT manufacturer's instructions for the proper network settings.

Highlight the box beside DVR Name and press the button to name the DVR to be registered on the DVRNS server. A virtual keyboard allows you to enter the DVR name.

Selecting Check allows you to check whether or not the name you entered can be used.

NOTE: The DVR name you entered should be checked by selecting *g Check*, otherwise the DVRNS changes will not be saved.

NOTE: When entering no name or the name already registered on the DVRNS server, an error message displays.

Highlighting OK and pressing the  button registers the DVR on the DVRNS server. Proper DVRNS settings will display the help desk information of the DVRNS server in the box beside Help Desk.

CAUTION: If you want to use the same DVR name registered on the DVRNS server after initializing the system using the factory reset, you need to contact the DVRNS server manager. Please record and keep the help desk information before factory reset.

CAUTION: The DVRNS registration will be limited to only one DVRNS server. The DVR cannot be registered to multiple DVRNS servers. Please contact your network administrator when you want to register to the other DVRNS server.

Callback Center Setup Screen

The DVR can be set up to contact a computer running RAS (Remote Administration System) on a LAN when an event occurs. Also it can be set up to dial a pager with a numeric message when an event occurs if you have a modem connected to the DVR.

Callback Center Setup by LAN connections

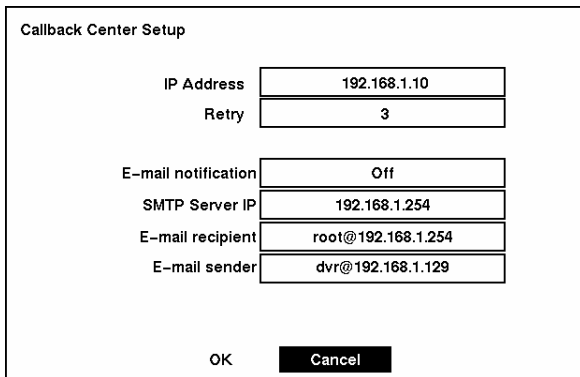

Callback Center Setup	
IP Address	192.168.1.10
Retry	3
E-mail notification	Off
SMTP Server IP	192.168.1.254
E-mail recipient	root@192.168.1.254
E-mail sender	dvr@192.168.1.129
OK	Cancel

Figure 70 — Callback Center (LAN) Setup screen.

Highlight the box beside IP Address and enter the IP address of the computer you want contacted during an event.

Highlight the box beside Retry and enter the number of times you would like the DVR to try contacting the computer. You can select from 1 to 10 retries.

Highlight the box beside E-mail notification and press the  button to toggle between On and Off.

Highlight the box beside SMTP Server IP and enter the SMTP server IP address, obtained from your system administrator.

Highlight the box beside E-mail recipient and enter the recipient's e-mail address. Use the virtual keyboard to enter the e-mail address.

Highlight the box beside E-mail sender and enter the sender's e-mail address.

NOTE: The e-mail address must include the character "@" to be a valid address.

Callback Center Setup by Modem connections

Callback Center Setup

Pager Number

Mailbox

Site ID

Event _____

ID	Event	ID	Event
1	Alarm In	10	Recorder Bad
2	Text-In	11	Storage
3	Motion	13	S.M.A.R.T.
4	Video Loss		

Figure 71 — Callback Center (Modem) Setup screen.

Highlight the box beside Pager Number and enter the telephone number of the pager. Enter the number as it must be dialed from your telephone system; e.g., if you must dial "9" for an outside line, enter "9" before the pager number.

Highlight the box beside Mailbox and enter the voice mailbox number if your pager uses a voice mailbox.

Highlight the box beside Site ID and enter a three-digit site ID number.

When an event occurs, the DVR will dial the pager and leave a four-digit number. The first three digits are the site ID number and the last digit is the type of event (1: Alarm In, 2: Text-In, 3: Motion Detection, 4: Video Loss, 10: Recorder Bad, 11: Storage and 13: S.M.A.R.T.). For example, "0754" means that Site 75 has lost video.

NOTE: The DVR will wait for at least four minutes between pages. If another event occurs less than four minute after the DVR has notified a pager, it will not dial the pager. It does this so that the telephone line will not be tied up.

You can save your changes by highlighting OK and pressing the  button. Selecting Cancel exits the screen without saving the changes.

Password Setup Screen

An Administrator password is required to turn the system off, enter the setup screen, load default setups, clear all data, change system date and time and change the Administrator password. A User password is required to enter playback, fast forward playback and fast backward playback modes from live monitoring mode, and enter the search menu screen in live monitoring mode. Highlight **Password** in the Main menu and press to enter the **Password** screen.

Permission	On/Off	Password
User	On	*****
Admin Setup		*****

Key Lock On

OK Cancel

Figure 72 — Password setup screen.

Highlight the box beside **User** and press the button to toggle between **On** and **Off**. If the password is set to **On**, you will be asked to enter the current password so that you can turn it **Off**. If the password is set to **Off**, you will be asked to enter the new password and to confirm it before it will be turned on.

The Administrator password cannot be turned **On** and **Off**. You can change the Administrator password by first entering the current password, entering a new password and finally confirming the new password.

To change the password, highlight the **Password** box and press the button. A window appears asking you to enter the current password. If you enter the correct password, another window appears asking you to enter a new password using the camera buttons. After you press the button, another screen appears asking you to confirm the new password.

NOTE: The **Admin** and **User** passwords are composed of up to eight digits using the camera buttons. The default **Admin** password is **4321**.

CAUTION: Write down the new password and save it in a secure place. If the password is forgotten, the unit must be reset using the **Factory Reset Button** and all data settings will be lost.

To lock front panel buttons, highlight **Key Lock On** and press the button. Once the buttons are locked, pressing any front panel button will cause a password screen to display. You will need to enter the correct password to unlock the keys. The **Key Lock** password is **4321**. The Administrator password also can be used to unlock the keys.

You can save your changes by highlighting OK and pressing  button. Selecting Cancel exits the screen without saving the changes.

Config Screen

The Config menu is used to perform functions such as switching between Quick Setup and Normal Setup, backing up video, loading default setup and clearing all data.

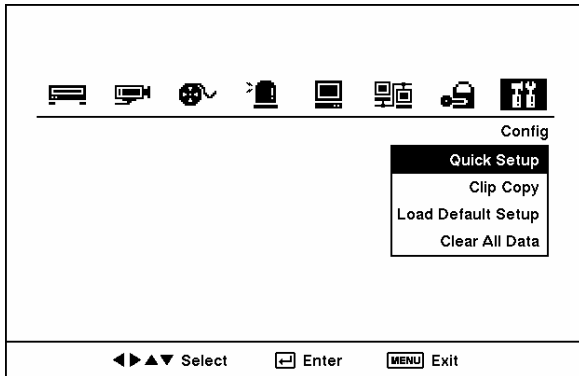

Figure 73 — Config screen.

Clip Copy

The Clip Copy screen can be used to back up video to an internal CD-RW drive, external USB hard disk drive, USB CD-RW drive or USB flash drive. The backup clip images can be viewed on computers running Microsoft Windows 98, ME, 2000 or XP. Refer to the *Appendix A — USB Hard Disk Drive Preparation* for information on preparing the external drive for back up.

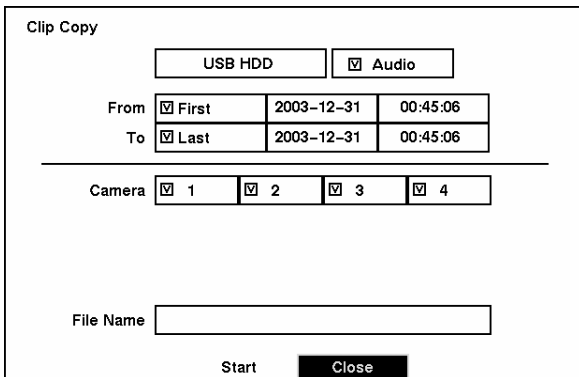

Figure 74 — Clip Copy screen.

To select the type of the drive to use for back up, highlight the box on the top and press the button. A drop-down list of available drives appears. You can select IDE CD-RW, USB HDD, USB CD-RW or USB Flash Memory.

If you want to archive audio with video, place a checkmark in the Audio box.

You can define how much video to back up by changing the start and end times and dates. You can also select which camera you wish to back up.

Highlight the File Name box and press the button. A virtual keyboard appears. Enter a file name for the video you are backing up and select Close. The DVR will automatically add the camera number (for example "01") and ".exe" to the file name. If you want to save the file in a specific folder, enter the folder name followed by a "/". For example: "folder/filename"

Once you have given the video a file name, highlight the Start button and press the button. The DVR will display the drive capacity, the backup file size and ask if you want to continue.

When the selected drive has more than 2 partitions, the following Disk Partition Selection screen appears. If the file system is not FAT32, the TYPE displays NOT Supported.

Searching USB device

USB FLASH MEMORY Audio

From First 2004-09-23 08:25:30

To

Camera

Return to Clip Copy Menu

PART.1 - TYPE: FAT16 (10GB)

PART.2 - TYPE: FAT32 (10GB)

PART.3 - TYPE: NOT Supported (10GB)

PART.4 - TYPE: FAT32 (10GB)

File Name aaa

Cancel Close

Figure 75 — Disk Partition Selection screen.

Once you select the drive and partition to use for clip copy, the DVR will display the drive capacity and the clip size, and ask if you want to continue.

NOTE: Do not back up files larger than 2GB.

You can use other functions on the DVR while video is being backed up. To do this, highlight the Close button and press the button. You can return to the Clip Copy screen at any time to check the progress.

NOTE: You cannot end the archiving process during CD burning.

Refer to the *RAS User's Manual* for instructions on how to review the images you have backed up.

NOTE: During clip copy, you cannot change the system date and time, shut the system down, switch to the Quick Setup mode, clear all data, and change the system setup from a remote site.

NOTE: The recording speed will be decreased to 1 ips per camera during CD burning, or while the DVR is preparing clip copy data on hard disk drive.

CAUTION: Do NOT use poor quality CD-R or CD-RW discs or ones that have been scratched or damaged in any way.

CAUTION: Do NOT disconnect the USB cable or the power from the external drive while backing up video. If the external drive is shut down or the USB cable is disconnected while backing up, THE DVR SYSTEM MAY NOT WORK NORMALLY OR THE EXTERNAL DRIVE COULD BE DAMAGED, and you will get an error message the next time you try to back up. You will need to power down the DVR and restart it to get rid of the error message. Once the file system of the USB-IDE hard disk drive has been corrupted, this error message cannot be dismissed. Even after restarting the DVR it may automatically restart while preparing a backup. You must recover the file system using the recovery program, or you must reformat the hard disk drive.

Load Default Setup

Highlighting and selecting Load Default Setup will bring up screen asking you if you really want to load default settings and confirm it with a password.

NOTE: Loading the Default Setup will not change the current time, time zone, daylight saving time and network settings.

Clear All Data

Highlighting and selecting Clear All Data will bring up screen asking you if you really want to clear all data and confirm it with a password.

CAUTION: Selecting *Clear All Data* will erase all recorded video.

Chapter 4 — Operation

NOTE: This chapter assumes your DVR has been installed and configured. If it has not, please refer to Chapter 2 and 3.

The DVR's controls are similar to a VCR. As with a VCR, the main functions are recording and playing back video. However, you have much greater control over recording and playing back video. You can establish recording schedules based on time of day and day of the week. The DVR allows you to search through the recorded video using much more sophisticated tools than those available with VCRs. Additional DVR features that are not available with VCRs are remote control and viewing and recording video at the same time you are watching previously recorded video. The DVR is operating even when no hard disk drives are installed. In this case recording, playback and any process to access hard disk drives are not supported. You can only view live video, establish system settings except for settings related to hard disk drive operating. Also the unit can be connected with RAS Watch either Ethernet or modem.

The Front Panel controls are described in *Chapter 3 — Configuration*.

Turning on the Power

Once you have installed the DVR following the instructions in *Chapter 2 — Installation*, it is ready to record.

The unit will take approximately 60 seconds to initialize.

The DVR will be recovered automatically once the unit is initialized when recorded data on the storage device has been damaged.

Live Monitoring

As soon as the DVR completes its initialization process, it will begin showing live video on the attached monitor and playing live audio through the attached speaker. The default mode is to display 4 cameras at once. Pressing any camera button will cause that camera to display full screen. It displays live video and plays live audio until the user enters another mode.

Pressing the **QUAD/SEQ** button toggles between quad (2x2) display mode and sequence mode.

Pressing the **ENTER** button in the Live Monitoring mode will freeze the current image on the screen until you press the button again. The screen displays *

The DVR can be set to display the event-detected video in full-screen on the monitor during the preset dwell time when there is an Event. The video of the lowest camera number among cameras associated with the event-detected sensor will be displayed, and the DVR will return to the previous screen format after event monitoring dwell time. While the event monitoring is activated, the monitoring for all other subsequent events will be ignored. Pressing the individual camera button or the **QUAD/SEQ** button during event monitoring releases the current event monitoring and displays the selected camera or return to the previous screen format.

The DVR will display the text-in data if there is any text input during live monitoring. The text-in information will display on the image.

NOTE: The text-in displays only in full screen.



Figure 76 — Live Monitoring (Text-In) screen.

PTZ Mode

The DVR will control cameras with Pan, Tilt and Zoom capabilities. Pressing the **PTZ** button enters the PTZ mode. You can control the camera using front panel control buttons or by setting up presets. Press the arrow buttons to pan left and right, and tilt the camera up and down. Use **CAMERA 1** and **CAMERA 2** to zoom in or zoom out. **CAMERA 3** and **CAMERA 4** can be used to focus the image.

NOTE: When the DVR is in the PTZ mode, a white line will display around the image.

NOTE: You cannot enter the PTZ mode when the selected camera is Off, has lost or is set to Covert.

Pressing the **MENU** button in the PTZ mode displays the PTZ Menu screen.

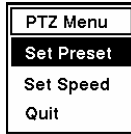

Figure 77 — PTZ Menu.

- **Set Preset** — Sets the Presets for PTZ camera
- **Set Speed** — Sets the pan and tilt speed for PTZ camera
- **Quit** — Closes the menu

Set Preset

Once you have the camera at the desired settings, you can save camera position settings as “presets” so that you can go directly to desired views. Select **Set Preset** in the PTZ Menu. Select the number you want to assign to the preset and press the **←** button. Use the virtual keyboard to enter the preset name and enter the **←** button again to save as preset.

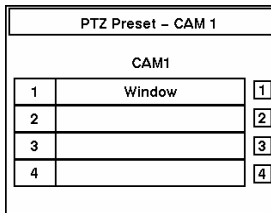

Figure 78 — PTZ Preset screen.

Preset View

Once you have set the camera presets, you can go directly to desired views. Press the **QUAD/SEQ** button to load the **Preset View** dialog box. Selecting the desired preset number loads the preset.

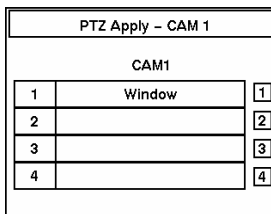

Figure 79 — Preset view screen.

Set Speed

Select **Set Speed** in the PTZ Menu and change the number from 1 to 16 using the **Left** and **Right** arrow buttons. Once you have set the speed you want, press the **↔** button. If the camera does not support the speed control, **Set Speed** menu cannot be selected.

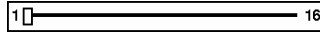

Figure 80 — PTZ speed controller.

Digital Zoom Mode

You can enter the **Digital Zoom Mode** by pressing the **PTZ** button in the PTZ mode. When a PTZ device is not installed, pressing the **PTZ** button in the live monitoring mode enters the **Digital Zoom Mode** directly.

NOTE: You cannot enter the Digital Zoom mode when the selected camera is Off, has lost or is set to Covert.

Once you are in the **Digital Zoom mode**, a bright small box is laid over the image. The box indicates the area to be enlarged. Move the position of that box using the arrow buttons, and press the **↔** button to enlarge that area. A **⊕** displays on the enlarged screen. Pressing the **PTZ** button again returns the DVR to the **Live Monitoring mode**.

Recording Video

Once you have installed the DVR following the instructions in *Chapter 2 — Installation*, it is ready to record. Unless you change the setup, the DVR is recording video and will continue recording until the hard disk drive is full. The factory default is **Stop** when the hard disk drive is full. The DVR can be set to continue recording (**Overwrite**) once the hard disk drive is full. It does this by recording over the oldest video.

Although you will be able to record without changing the unit from its original factory settings, you will want to take advantages of the DVR's many tools. See *Chapter 3 — Configuration* for detailed descriptions of the recording mode options.

NOTE: When the DVR is recording video, the REC LED on the front panel is lit and a red dot appears on the monitor.

Although you have set time-lapse or event recording, pressing the **PANIC** button activates panic recording, so the DVR will record video regardless of the time-lapse or event recording schedule. Press the button again to release the panic recording.

NOTE: When the DVR is in the panic recording mode, a white ! appears in the red dot which indicates the DVR is recording, and the REC LED on the front panel flickers.

Recording Audio

If the DVR was set up to record audio, it will record audio when video is recording.

NOTE: Make certain you comply with all local and federal laws and regulations when recording audio.

Playing Recorded Video

Once video has been recorded, you can view it using the arrow buttons. When playing video for the first time, the DVR will display the most recent image. When playing video subsequent times, the DVR will start playing video from the last recalled image.

When playing video, the DVR will display the text-in data if there is any text input. The text-in information will display on the image.

NOTE: The text-in displays only in full screen.

NOTE: Make sure that *Text-In* should be turned On during OSD setup if you want to display the text-in information on the playback image.



Figure 81 — Playback (Text-In) screen.

Arrow Buttons

◀: Pressing the left-arrow button plays video backward at high speed. Pressing the button again toggles the playback speed from ◀◀, ◀◀◀ and ◀◀◀◀. The screen displays ◀◀, ◀◀◀ and ◀◀◀◀ respectively.

▶: Pressing the right-arrow button plays video forward at high speed. Pressing the button again toggles the playback speed from ▶▶, ▶▶▶ and ▶▶▶▶. The screen displays ▶▶, ▶▶▶ and ▶▶▶▶ respectively.

▶: After selecting **ENTER/PAUSE**, press the up-arrow button to advance to the next image.

◀: After selecting **ENTER/PAUSE**, press the down-arrow button to review to the previous image.

NOTE: Entering Fast/Backward Playback mode from Live Monitoring mode can be password protected.

Enter Button

Pressing the **ENTER/PAUSE** button will pause the video on the screen. The screen displays **||**.

Camera Buttons (1 to 4)

Pressing a camera button will display that camera full screen.

QUAD/SEQ Button

When playing back video, you can change the display format from full screen to quad (2x2) mode by pressing the **QUAD/SEQ** button. However, changing the display format from quad (2x2) to full screen is not available.

Shuttle Ring

The Shuttle Ring functions in the Playback mode. The Shuttle Ring is spring loaded and returns to the center position when released. Turning the ring clockwise plays video forward. Turning the ring counterclockwise plays video backward. Playback speed varies with the amount the ring is turned. The playback speeds are ◀x0.5, ◀◀, ◀◀◀, ◀◀◀◀, ▶x0.5, ▶, ▶▶, ▶▶▶ and ▶▶▶▶.

When you release the ring, it snaps back to the center position and the video pauses.

Jog Dial

The Jog Dial functions when playback video has been paused. By turning the jog dial clockwise, you can play video forward image-by-image. By turning the jog dial counterclockwise, you play video backward image-by-image.

NOTE: When playing recorded video at maximum speed with very high image quality, playback of recorded audio may be interrupted occasionally.

NOTE: The user cannot change the system setup from a remote site during Playback mode.

Digital Zoom Playback Mode

You can enter the Digital Zoom Playback mode by pressing the **PTZ** button in the Playback mode. Once you press the **PTZ** button in the playback mode, the image pauses and a bright small box is laid over the image. This box indicates the area to be enlarged. Move the position of the box using the arrow buttons, and press the **+** button to enlarge that area. The enlarged screen displays **⊕**. Pressing the **PTZ** button again releases the Digital Zoom Playback mode and returns to the playback mode.

NOTE: You cannot enter the Digital Zoom Playback mode when the selected camera is set to Covert and not played back.



Figure 82 — Digital Zoom screen.



Figure 83 — Enlarged Digital Zoom screen.

Searching Video

Pressing the **MENU** button in the playback mode displays the Search Menu.

Go to the First
Go to the Last
Date/Time Search...
Calendar Search...
Event Search...
Text-In Search...
Clip Copy...

Figure 84 — Search Menu.

- Go to the First — Displays the first recorded image
- Go to the Last — Displays the last recorded image
- Date/Time Search... — Searches by date and time (see below for more details)
- Calendar Search... — Searches using a calendar (see below for more details)
- Event Search... — Selects video from the event log (see below for more details)
- Text-In Search... — Searches text input strings (see below for more details)
- Clip Copy... — Clips a video segment and saves it

Date/Time Search

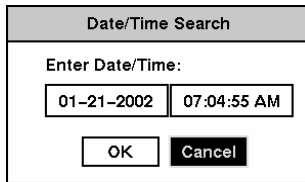

Figure 85 — Date/Time Search screen.

Move the cursor over the date and press the button. Adjust the numbers using arrow buttons or Jog Dial. Once you have set the date you want to search for video, press the button.

Move the cursor over the time and press the button. Adjust the numbers using arrow buttons or Jog Dial. Once you have entered the time you want to search for video, press the button.

Once you have set the date and time you want to search, highlight the OK button and press the button. The selected date and time will display. (If no video was recorded at the selected time, a blank screen will display.) The arrow buttons, Jog and Shuttle can now be used to review the surrounding video.

Calendar Search

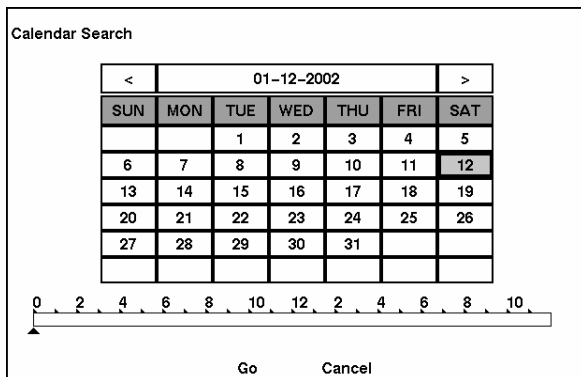



Figure 86 — Calendar Search screen.

Days with recorded video display on the calendar with white numbers. Highlight a day using arrow buttons and press the  button to select it.

A time bar will display at the bottom of the calendar. Hours in which video was recorded will be highlighted with blue. Highlight the time bar and select the time using the arrow buttons.



NOTE: The time bar is in one-hour segments. If a segment is highlighted, it means that some video was recorded during that hour. However, it does NOT mean video was recorded for the entire hour.

Once you have set the date and time you want to search, highlight the GO button and press the  button. The selected date and time will display. The arrow buttons, Jog and Shuttle can now be used to review the surrounding video.

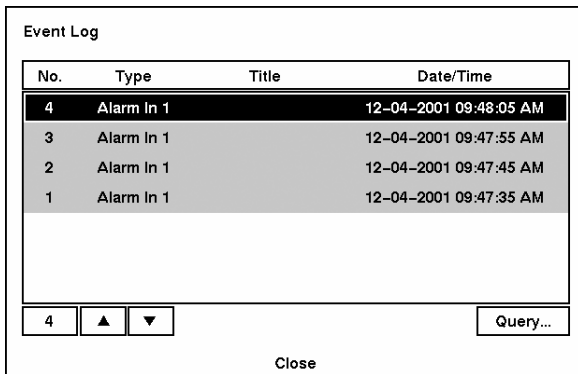
Event Search



No.	Type	Title	Date/Time
4	Alarm In 1		12-04-2001 09:48:05 AM
3	Alarm In 1		12-04-2001 09:47:55 AM
2	Alarm In 1		12-04-2001 09:47:45 AM
1	Alarm In 1		12-04-2001 09:47:35 AM

4   Query...

Close

Figure 87 — Event Log screen.

The DVR maintains a log of each time the Alarm Input port is activated. The Event Log screen displays this list. Highlight the event for which you would like to see video.

Pressing the  button will extract the event video and display the first image of the event. Pressing the arrow button will start playing the “event” video segment. Pressing the **ENTER/PAUSE** button pauses the video, and pressing the button again returns to live monitoring.

You can also narrow your event search by selecting the Query... button and setting up the new search condition.

Event Search

Search by

From	<input checked="" type="checkbox"/> First	2004-05-12	03:14:33
To	<input checked="" type="checkbox"/> Last	2004-05-12	03:14:33

	1	2	3	4
Alarm In	<input checked="" type="checkbox"/>	<input checked="" type="checkbox"/>	<input checked="" type="checkbox"/>	<input checked="" type="checkbox"/>
Motion	<input checked="" type="checkbox"/>	<input checked="" type="checkbox"/>	<input checked="" type="checkbox"/>	<input checked="" type="checkbox"/>
Video Loss	<input checked="" type="checkbox"/>	<input checked="" type="checkbox"/>	<input checked="" type="checkbox"/>	<input checked="" type="checkbox"/>

Find

Figure 88 — Event Search (by Event) screen.

Event Search

Search by

From	<input checked="" type="checkbox"/> First	2004-07-25	23:49:48
To	<input checked="" type="checkbox"/> Last	2004-07-25	23:49:48

Camera	<input checked="" type="checkbox"/> 1	<input checked="" type="checkbox"/> 2	<input checked="" type="checkbox"/> 3	<input checked="" type="checkbox"/> 4
--------	---------------------------------------	---------------------------------------	---------------------------------------	---------------------------------------

Event	<input checked="" type="checkbox"/> Alarm In
	<input checked="" type="checkbox"/> Motion
	<input checked="" type="checkbox"/> Video Loss

Find

Figure 89 — Event Search (by Camera) screen.

Highlight the box beside Search by and press the button to toggle between Event and Camera.

You can search video from the first to last recorded images, or you can set the start and stop times and dates.

When you select the Search by Camera, select the target cameras and event options. When you select the Search by Event, select event options for each device.

Once you set your desired search conditions, highlight Find and press the button to display the search results in the Event Log screen. Selecting Cancel exits the screen without saving the changes.

Text-In Search

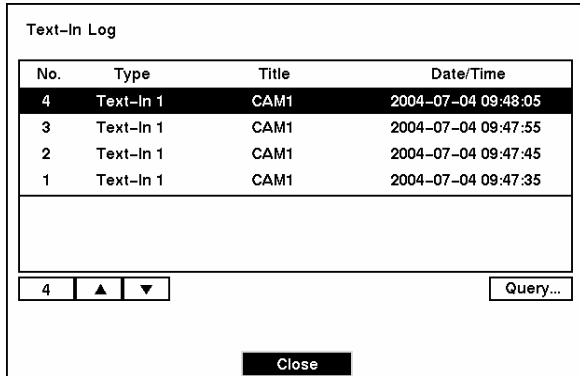

Figure 90 — Text-In Log screen.

The DVR maintains a log of each time there is Text Input. The Text-In Log screen displays this list. Highlight the event for which you would like to see video.

Pressing the button will extract the event video and display the first image of the event. Pressing the arrow button will start playing the “text-in” video segment with the text-in data on the image. Pressing the **ENTER/PAUSE** button pauses the video, and pressing the button again returns to live monitoring.

You can also narrow your event search by selecting the Query... button and setting up the new search condition.

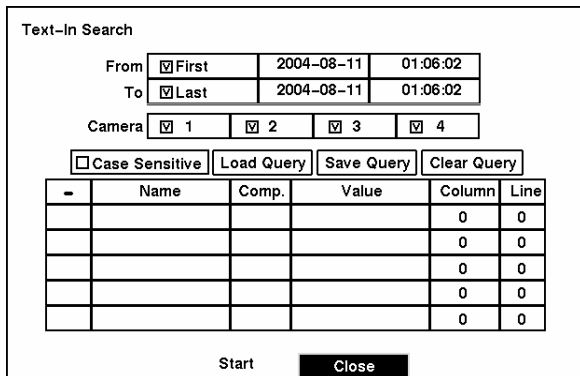





Figure 91 — Text-In Search screen.

You can search video from the first to last recorded images, or you can set the start and stop times and dates.

Select the target cameras to search text-in data.

Highlight the **Case Sensitive** box and press the  button to toggle between On and Off. If the **Case Sensitive** box is turned On, the DVR distinguishes between upper and lower case letters.

Highlight the **Load Query** box and press  the button to load the saved Query settings.

Highlight the **Save Query** box and press the  button to save the current Query settings. Enter the title for the current Query option using the virtual keyboard.

Highlight the **Clear Query** box and press  button to delete the current Query settings.

Highlight the **Name** box and enter the text to search using the virtual keyboard.

Highlight the **Comp.** box and enter the comparison operator using the virtual keyboard.

Highlight the **Value** box and enter the comparison value using the virtual keyboard.

NOTE: The *Column* and *Line* can be used for more specific search of the text-in data. *Column* indicates the location of each individual category, and *Line* indicates the line where the category is located. Change the number of *Column* and *Line* by highlighting it and using the Up and Down arrow buttons to increase and decrease the number.

NOTE: Enter *AND* or *OR* in the box under – heading for more specific text-in data search.

Once you set your desired search conditions, highlight **Start** and press the  button to display the search results in the **Text-In Log** screen. Selecting **Close** exits the screen and returns to the previous screen.

Appendix A — USB Hard Disk Drive Preparation

Preparing the USB-IDE hard disk drive in Windows 2000

NOTE: Preparing a USB-IDE hard disk drive under Windows XP is almost identical to Windows 2000.

1. Connect the USB-IDE hard disk drive to your computer using the USB Cable.
2. Turn on your computer.
3. The USB device icon should display on the Taskbar.
4. If the USB-IDE hard disk drive is partitioned or has data, it will show up in *My Computer* as a hard disk drive icon. Check the file system by right clicking on the icon and checking under *Properties > General > File System*. If the file system is NOT FAT32 format, format the USB-IDE hard disk drive using the FAT32 format.
5. If the USB-IDE hard disk drive is not partitioned, go to *Administrative Tools* in *Control Panel* and launch *Computer Management*. Open *Disk Management* in *Storage* and right click an unallocated region of the USB-IDE hard disk drive. Then, click *Create Partition*.
6. In the *Create Partition wizard*, click *Next* then *Primary Partition*, and follow the instructions on the screen. Make sure that the FAT32 is selected for the file system.

NOTE: The partition size should be less than 32GB because of Windows OS limitations.

After formatting is complete, the USB-IDE hard disk drive will be added to *My Computer*.

7. Connect the USB-IDE hard disk drive to the DVR.

Preparing the USB-IDE hard disk drive in Windows 98

NOTE: Preparing a USB-IDE hard disk drive under Windows ME is almost identical to Windows 98.

1. Connect the USB-IDE hard disk drive to your computer using the USB Cable.
2. Turn on your computer. The *Add New Hardware wizard* window will appear.
3. Install the device driver for the USB backup device following the instructions provided with your USB hard disk drive.
4. If the USB-IDE hard disk drive is partitioned or contains data, it will show up in *My Computer* as a hard disk drive icon. Check the file system in *Properties > General > File System*. If the file system is NOT FAT32 format, format the USB-IDE hard disk drive with FAT32 format.
5. Run the FDISK utility by clicking *Start* then *RUN*. Type “fdisk” and click OK.
6. When the MS-DOS command prompt appears, type “Y” and hit the enter key.
7. In the FDISK Option menu, choose “5. Change current fixed disk drive.”
8. Choose the appropriate letter corresponding to the USB-IDE hard disk drive.
9. In the FDISK Option menu, choose “1. Create DOS partition or Logical DOS Drive.”

10. In the Create DOS Partition or Logical DOS Drive menu, choose “1. Create Primary DOS Partition.” And Type “Y” to use all available space and hit the enter key. Hit ESC to exit the screen after the USB-IDE hard disk drive partition is created.
11. Restart your computer and verify the newly created drive is in *My Computer*.
12. Right click the newly created hard disk drive icon and select “Format”.
13. In the Format Screen, select “Full” as the “Format type” and click “Start”.
14. After formatting is complete, connect the USB-IDE hard disk drive to the DVR.

Appendix B — Text-In Query Examples

Query Example I

1 2 3 4 5 6
 123456789012345678901234567890123456789012345678901234567890

Item	Unit price	Qty	amount
Coke	\$ 2.20	1(s)	\$ 2.20
Fanta	\$ 2.20	1(s)	\$ 2.20
Hotdog	\$ 3.50	3(s)	\$ 10.50
Pepsi	\$ 1.95	1(s)	\$ 1.95
total : \$			16.85

Thank you~~

In the above text-in data, you can find that the comparison value is located at 17th (Unit price, \$ mark will be ignored automatically), 28th (Qty) and 40th (amount) characters (including spaces) from the left. In this case, you can enter “17”, “28” and “40” in each Column box.

For example, if you want to search for Coke with a Qty (Quantity) of more than 1 and Hotdog with an amount totaling over \$8, the following search condition can be set.

Text-In Search

From First 2004-08-11 01:06:02

To Last 2004-08-11 01:06:02

Camera 1 2 3 4

Case Sensitive Load Query Save Query Clear Query

-	Name	Comp.	Value	Column	Line
	Coke	>	1	28	0
AND	Hotdog	>	8	40	0
				0	0
				0	0
				0	0

Start Close

Query Example II

1 2 3 4 5 6
 123456789012345678901234567890123456789012345678901234567890

Item	Unit price	Qty	amount
Coke	\$ 2.20	1(s)	\$ 2.20
Fanta	\$ 2.20	1(s)	\$ 2.20
Hotdog	\$ 3.50	3(s)	\$ 10.50
Pepsi	\$ 1.95	1(s)	\$ 1.95
total : \$			16.85

Thank you~~

In the above text-in data, you can find that the comparison value is located at 17th (Unit price, \$ mark will be ignored automatically), 28th (Qty) and 40th (amount) characters (including spaces) from the left, but the value of amount category is located at the different line from Item. In this case, you can enter “17”, “28” and “40” in each Column box and enter “1” in the Line box for the next line.

For example, if you want to search for Coke with a Qty (Quantity) of more than 1 and Hotdog with an amount totaling over \$8, the following search condition can be set.

Text-In Search

From First 2004-08-11 01:06:02
 To Last 2004-08-11 01:06:02

Camera 1 2 3 4

Case Sensitive Load Query Save Query Clear Query

-	Name	Comp.	Value	Column	Line
	Coke	>	1	28	0
AND	Hotdog	>	8	40	1
				0	0
				0	0
				0	0

Start Close

Appendix C — Troubleshooting

Problem	Possible Solution
No Power	<ul style="list-style-type: none"> • Check power cord connections. • Confirm that there is power at the outlet.
No Live Video	<ul style="list-style-type: none"> • Check camera video cable and connections. • Check monitor video cable and connections. • Confirm that the camera has power. • Check camera lens settings. • Check CVBS (SVHS)/VGA switch settings.
Live Video Very Bright	If a cable is attached to the “Loop” connector, make certain it is connected to a properly terminated device.
DVR has stopped recording	If hard disk drive is full, you will either need to delete video or set the DVR to the Overwrite Mode.
DVR displays an error message stating that the last recorded image date and time is later than the current date and time setting of the DVR.	The DVR will automatically reset the time and date of the unit, according to the time and date of the last recorded image. If this is not the correct time and date, reset the time and date manually. If the correct time and date is earlier than the last recorded image, any video with a later time and date will be lost when resetting the correct time and date.

Appendix D — Connector Pin Outs

I/O Connector Pin Outs



Input

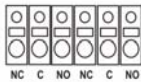

Output

AI (1 to 4)	Alarm Inputs 1 to 4
GND	Chassis Ground
ARI	Alarm Reset In
NC	Normally Closed
C	Common
NO	Normally Open

RS485 Connector Pin Outs



Master Unit	Slave Unit
RX-/TX- → To	→ TX-/RX-
RX+/TX+ → To	→ TX+/RX+

Appendix E — Map of Screens

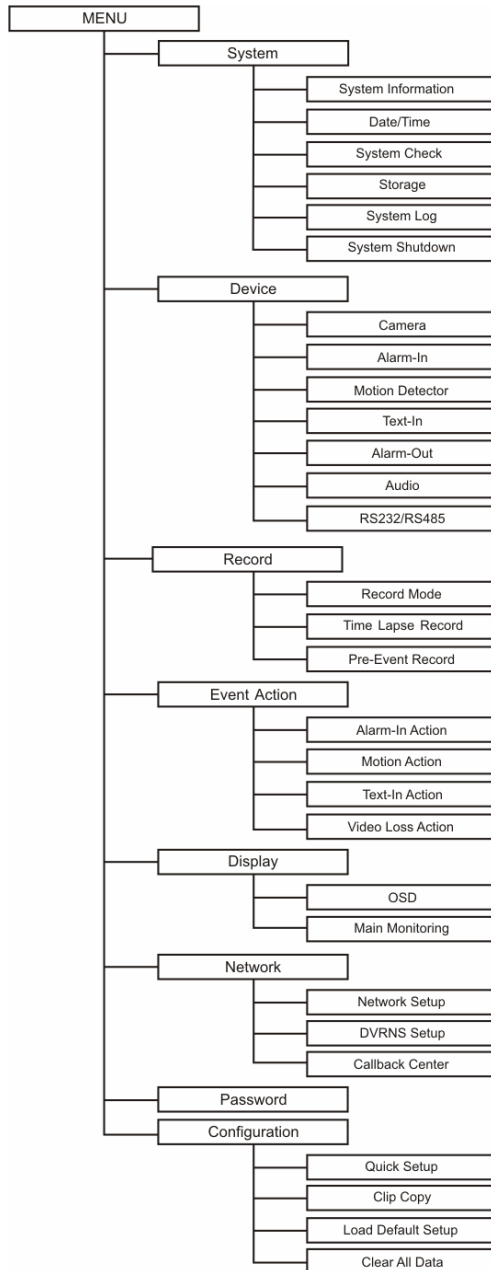

Appendix F — Specifications

VIDEO	
Signal Format	NTSC or PAL (auto detect)
Video Input	Composite: 4 looping inputs, 1 Vp-p, auto-terminating, 75 Ohms
Monitor Outputs	Composite: One (BNC), 1 Vp-p, 75 Ohms SVHS: One (Y/C) Analog RGB: One (VGA)
Video Resolution	720x480 (NTSC), 720x576 (PAL)
Playback/Record Speed (images per second)	Standard: 120ips (NTSC), 100ips (PAL) High: 60ips (NTSC), 50ips (PAL)

INPUTS/OUTPUTS	
Alarm Input	4 TTL, NC/NO programmable, 4.3V threshold
Alarm Output	2 relay out, terminal block, NC & NO, 0.5A @ 125VAC, 1A @ 30VDC
Alarm Reset Input	1 TTL, terminal block
Internal Buzzer	80db at 10cm
Network Connectivity	10/100 Base Ethernet, RS-232C for external modem
Audio Input	4 lines in
Audio Output	1 line

CONNECTORS	
Video Input	Composite: 4 BNC
Video Loop	Composite: 4 BNC
Monitor Output	Composite: 1 BNC SVHS: 1 Y/C* Analog RGB: 1 (VGA)
Audio In	4 RCA connector
Audio Out	1 RCA connector
Alarms	Terminal block
Alarm Reset In	Terminal block
Ethernet Port	RJ-45
RS-232C Serial Port	DB9 (P)
RS-485 Serial Port	4 connector terminal block
USB Port	1 on front panel (1.1)

* Using a shielded S-Video cable provides better quality video display and reduces image noise.

Specifications are subject to change without notice.

STORAGE	
Primary Storage	EIDE hard disk drive (up to 3)
Backup Storage	Built-in CD-RW drive USB hard disk drive or USB CD-RW drive

GENERAL	
Dimensions (W x H x D)	16.9" x 3.5" x 14" (430mm x 88mm x 355mm)
Unit Weight	17.64 lbs. (8.0kg)
Shipping Weight	22.44 lbs. (10.2kg)
Shipping Dimensions (W x H x D)	21.3" x 10.2" x 19.7" (540mm x 260mm x 500mm)
Operating Temperature	41°F to 104°F (5°C to 40°C)
Operating Humidity	0% to 90%
Power	115–230 V~, 50/60Hz, 2A
Approval	FCC, CE, CB, UL

Specifications are subject to change without notice.