

# Instruction and Operation M A N U A L

Color TFT-LCD Monitor Video / PC

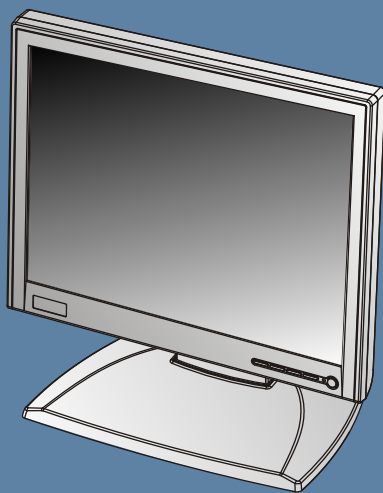

**17.0" / 19.0" Color TFT-LCD Monitor.  
Automatically displays NTSC and PAL  
in Composite and S-Video.**

Please read this manual thoroughly before use, and keep it handy for future reference.



## LIMITATION OF LIABILITY

The information in this publication is believed to be accurate in all respects. However, WE cannot assume responsibility for any consequences resulting from the use thereof. The information contained herein is subject to change WITHOUT NOTICE. Revisions or new editions to this publication may be issued to incorporate such changes.

## WARNINGS AND CAUTIONS:

TO REDUCE THE RISK OF FIRE OR ELECTRIC SHOCK, DO NOT EXPOSE THIS PRODUCT TO RAIN OR MOISTURE. DO NOT INSERT ANY METALLIC OBJECTS THROUGH THE VENTILATION GRILLS OR OTHER OPENINGS ON THE EQUIPMENT.

### CAUTION:

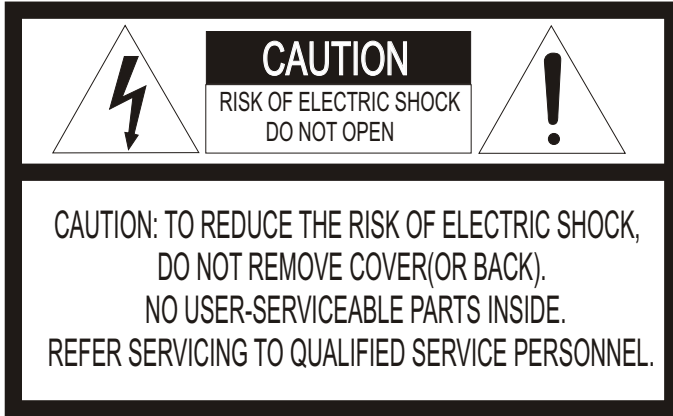

## EXPLANATION OF GRAPHICAL SYMBOLS



The lightning flash with arrowhead symbol, within an equilateral triangle, is intended to alert the user to the presence of uninsulated "dangerous voltage" within the product's enclosure that may be of sufficient magnitude to constitute a risk of electric shock to persons.



The exclamation point within an equilateral triangle is intended to alert the user to the presence of important operating and maintenance (servicing) instructions in the literature accompanying the product.

## PRECAUTIONS

### Safety -----

Should any liquid or solid object fall into the cabinet, unplug the unit and have it checked by the qualified personnel before operating it any further.

Unplug the unit from the wall outlet if it is not going to be used for several days or more. To disconnect the cord, pull it out by the plug. Never pull the cord itself.

Allow adequate air circulation to prevent internal heat build-up. Do not place the unit on surfaces (rugs, blankets, etc.) or near materials (curtains, draperies) that may block the ventilation holes.

Height and vertical linearity controls located at the rear panel are for special adjustments by qualified personnel only.

### Installation -----

Do not install the unit in an extremely hot or humid place or in a place subject to excessive dust, mechanical vibration.

The unit is not designed to be waterproof. Exposure to rain or water may damage the unit.

### Cleaning -----

Clean the unit with a slightly damp soft cloth. Use a mild household detergent. Never use strong solvents such as thinner or benzene as they might damage the finish of the unit.

Retain the original carton and packing materials for safe transport of this unit in the future.

## FCC COMPLIANCE STATEMENT

**INFORMATION TO THE USER :** THIS EQUIPMENT HAS BEEN TESTED AND FOUND TO COMPLY WITH THE LIMITS FOR A CLASS B DIGITAL DEVICE, PURSUANT TO PART 15 OF THE FCC RULES. THESE LIMITS ARE DESIGNED TO PROVIDE REASONABLE PROTECTION AGAINST HARMFUL INTERFERENCE IN A RESIDENTIAL INSTALLATION. THIS EQUIPMENT GENERATES, USES AND CAN RADIATE RADIO FREQUENCY ENERGY AND, IF NOT INSTALLED AND USED IN ACCORDANCE WITH THE INSTRUCTIONS, MAY CAUSE HARMFUL INTERFERENCE TO RADIO COMMUNICATIONS. HOWEVER, THERE IS NO GUARANTEE THAT INTERFERENCE WILL NOT OCCUR IN A PARTICULAR INSTALLATION. IF THIS EQUIPMENT DOES CAUSE HARMFUL INTERFERENCE TO RADIO OR TELEVISION RECEPTION, WHICH CAN BE DETERMINED BY TURNING THE EQUIPMENT OFF AND ON, THE USER IS ENCOURAGED TO TRY TO CORRECT THE INTERFERENCE BY ONE OR MORE OF THE FOLLOWING MEASURES :

- REORIENT OR RELOCATE THE RECEIVING ANTENNA.
- INCREASE THE SEPARATION BETWEEN THE EQUIPMENT AND RECEIVER.
- CONNECT THE EQUIPMENT INTO AN OUTLET ON A CIRCUIT DIFFERENT FROM THAT TO WHICH THE RECEIVER IS CONNECTED.
- CONSULT THE DEALER OR AN EXPERIENCED RADIO/TV TECHNICIAN FOR HELP.

**CAUTION :** CHANGES OR MODIFICATIONS NOT EXPRESSLY APPROVED BY THE MANUFACTURER COULD VOID THE USER'S AUTHORITY TO OPERATE THE EQUIPMENT.

THIS CLASS B DIGITAL APPARATUS COMPLIES WITH CANADIAN ICES-003.

CET APPAREIL NUMÉRIQUE DE LA CLASSE B EST CONFORME À LA NORME NMB-003 DU CANADA.

# IMPORTANT SAFEGUARDS

## 1. READ INSTRUCTIONS

All of the safety and operating instructions should be read before the appliance is operated.

## 2. RETAIN INSTRUCTIONS

The safety and operating instructions should be retained for future reference.

## 3. HEED WARNINGS

All warnings on the unit and in the operating instructions should be adhered to.

## 4. FOLLOW INSTRUCTIONS

All operating and use instructions should be followed.

## 5. CLEANING

Unplug the unit from the outlet before cleaning. Do not use liquid cleaners or aerosol cleaners. Use a damp cloth for cleaning. See cleaning procedures under Maintenance.

## 6. ATTACHMENTS

Do not use attachments not recommended by the product manufacturer as they may result in the risk of fire, electric shock, or injury to persons.

## 7. WATER AND MOISTURE

Do not use this unit near water or in an unprotected outdoor installation, or any area which is classified as a wet location.

## 8. ACCESSORIES

Do not place this product on an unstable cart, stand, tripod, bracket, or table. The product may fall, causing serious injury to a child or adult and serious damage to the equipment. Use only with a cart, stand, tripod, bracket, or table recommended by the manufacturer, or sold with the product. Any mounting of the product should follow the manufacturer's instructions and should use a mounting accessory recommended by the manufacturer. Wall or shelf mounting should follow the manufacturer's instructions and should use a mounting kit approved by the manufacturer.

## 9. A product and cart combination should be moved with care. Quick stops, excessive force, and uneven surfaces may cause the product and cart combination to overturn.

## 10. VENTILATION

Slots and openings in the cabinet and the back or bottom are provided for ventilation and to ensure reliable operation of the equipment and to protect it from overheating. These openings must not be blocked or covered. The openings should never be blocked by placing the product on a bed, sofa, rug, or other similar surface. Equipment should never be placed near or over a radiator or heat register. This product should not be placed in a built-in installation, such as a bookcase or rack unless proper ventilation is provided or the manufacturer's instructions have been adhered to.

## 11. POWER SOURCES

This product should be operated only from the type of power source indicated on the marking label. If you are not sure of the type of power supplied to your home, consult your product dealer or local power company. For products designed to operate from battery power or other sources, refer to the operating instructions.

## 12. GROUNDING OR POLARIZATION

The power supply supplied with this unit may be equipped with a polarized alternating-current line plug (a plug having one blade wider than the other). This plug will fit into the power outlet only one way. This is a safety feature. If you are unable to insert the plug fully into the outlet, try reversing the plug. If the plug should still fail to fit, contact your electrician to replace your obsolete outlet. Do not defeat the safety purpose of the polarized plug.

Alternately, this unit may be equipped with a 3-wire grounding-type plug, a plug having a third (grounding) pin. This plug will only fit into a grounding-type power outlet. This is a safety feature.

If you are unable to insert the plug into the outlet, contact your electrician to replace your obsolete outlet. Do not defeat the safety purpose of the grounding-type plug.

## 13. OVERLOADING

Do not overload outlets and extension cords as this can result in a risk of fire or electric shock.

# IMPORTANT SAFEGUARDS

## 14. POWER-CORD PROTECTION

Power supply cords should be routed so that they are not likely to be walked on or pinched by items placed upon or against them, paying particular attention to cords and plugs, convenience receptacles, and the point where they exit from the appliance.

## 15. OBJECT AND LIQUID ENTRY

Never push objects of any kind into this unit through openings as they may touch dangerous voltage points or short-out parts that could result in a fire or electric shock. Never spill liquid of any kind on the unit.

## 16. SERVICING

Do not attempt to service this unit yourself as opening or removing covers may expose you to dangerous voltage or other hazards. Refer all servicing to qualified service personnel.

## 17. DAMAGE REQUIRING SERVICE

Unplug the unit from the outlet and refer servicing to qualified service personnel under the following conditions:

- a. When the power-supply cord or plug is damaged.
- b. If liquid has been spilled, or objects have fallen into the unit.
- c. If the unit has been exposed to rain or water.
- d. If the unit does not operate normally by following the operating instructions. Adjust only those controls that are covered by the operating instructions as an improper adjustment of other controls may result in damage and will often require extensive work by a qualified technician to restore the unit to its normal operation.
- e. If the unit has been dropped or the enclosure has been damaged.
- f. When the unit exhibits a distinct change in performance - this indicates a need for service.

## 18. REPLACEMENT PARTS

When replacement parts are required, be sure the service technician has used replacement parts specified by the manufacturer or have the same characteristics as the original part. Unauthorized substitutions may result in fire, electric shock or other hazards.

## 19. SAFETY CHECK

Upon completion of any service or repairs to this unit, ask the service technician to perform safety checks to determine that the unit is in proper operating condition.

## 20. LIGHTNING

For added protection of this unit during a lightning storm, or when it is left unattended and unused for long periods of time, unplug it from the wall outlet and disconnect the cable system. This will prevent damage to the unit due to lightning and power-line surges.

## 21. OUTDOOR ANTENNA GROUNDING

If an outside antenna or cable system is connected to the product, be sure the antenna or cable system is grounded so as to provide some protection against voltage surges and built-up static charges.

## 22. POWER LINES

An outside antenna system should not be located in the vicinity of overhead power lines or other electric light or power circuits, or where it can fall into such power lines or circuits. When installing an outside antenna system, extreme care should be taken to keep from touching such power lines or circuits as contact with them might be fatal.

## 23. HEAT

The product should be situated away from heat sources such as radiators, heat registers, stoves, or other products (including amplifiers) that produce heat.

## 24. INSTALLATION

Do not install the unit in an extremely hot or humid location, or in a place subject to dust or mechanical vibration. The unit is not designed to be waterproof. Exposure to rain or water may damage the unit.

# TABLE OF CONTENTS

<b>Features</b> .....	<b>7</b>
<b>Operating Instructions - Controls</b> .....	<b>8~9</b>
<b>Connections</b> .....	<b>10</b>
<b>User Controls</b> .....	<b>9</b>
<b>Specifications</b> .....	<b>11~13</b>
<b>Dimensional drawings</b> .....	<b>14~16</b>



# CHAPTER 1 - Features

- High Quality Advanced CCTV LCD Monitor
- Incredible Resolution with 540TVL
- De-Interlace technology Efficiently Eliminates Shaky and blurry image
- Progressive Scan
- 3D Comb Filter Function Clear image
- Superior Color Reproduction
- VESA Wall & Ceiling mount Compatible
- Noise Reductions
- Single control operated On-Screen Display user interface

# CHAPTER 2 - Operating instruction

## ▣ FRONT controls

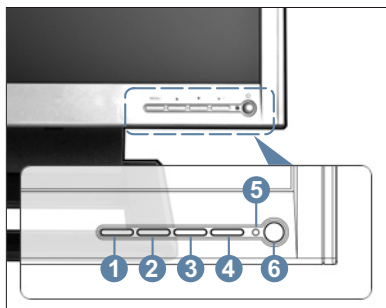

### 1. Menu / Exit

This button is used to bring up or disappear the controls menu.  
Exits from the OSD system and the selected function

### 2. ▼(Down) / ⚙(Brightness)

Moves down the menu lists in the OSD  
Selected brightness and decreases the value of brightness

### 3. ▲(UP) / Source

Moves up the menu lists in the OSD  
While in the normal active (Not MENU DISPLAY) mode, this button is used to bring up Source select Menu (CVBS, S-VIDEO, RGB)

### 4. ↵(Select) / ❄(Freeze) / AUTO

This ↵ button to choose on the menu then pushes the button:  
While in the CVBS, S-Video mode, press this button to FREEZE (❄) the picture for display  
Press again to exit the FREEZE image  
While in the RGB mode, press this button to AUTO adjust the H/V POS, H/V SIZE, and phase.

### 5. LED

A green indicator lights when the power is ON and input signal (the indicator blink when the power is ON and Input No signal.) A red indicator lights when the power is OFF

### 6. Power ON/OFF

When power is applied, the monitor will come ON. This button then turns the monitor ON and OFF.

## ▣ REAR connection

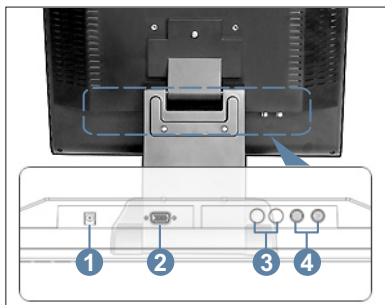

### **1. DC JACK**

Place the plug from the supplied table-top power supply into the DC 12V connector.

Input at the monitor is 12 volts DC from the TT universal AC supply (100-240 Vac, see specifications table for AC/DC details).

### **2. RGB INPUT**

Connect to the video output port on your PC or DVR

### **3. S-Video INPUT**

Used to connect a S-Video signal from a camera or DVR

### **4. CVBS INPUT**

Used to connect a BNC Video signal from a camera or DVR

# CHAPTER 3 - Connections

To make a normal connection to the monitor, bring a cord from a camera, or other video source to one of the BNC jacks or from a PC to the PC jack on the back of the monitor.

Either the left or right BNC jack can be used for input. The other jack may be optionally connected to another user of the same signal.

**Auto Termination** The input circuit of the monitor normally terminates the incoming cable in  $75 \Omega$ , but these BNCs jack are auto-terminating. When two cables are connected, the internal termination is switched out, letting the final destination equipment provide the end termination.

This arrangement is also specially offered for the Y/C (S-Video) jacks.

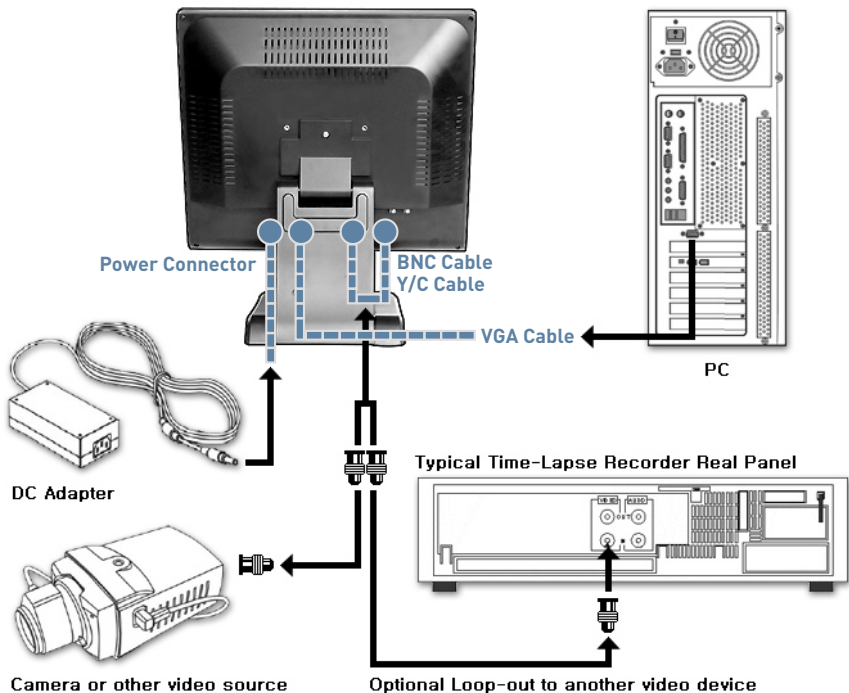

## \* Supplied item

- LCD monitor
- Power supply unit (DC 12V) / Power cord
- VGA Cable
- Operating instructions manual

# CHAPTER 4 - User Controls

## ▣ RGB (PC) Mode

Press the MENU button to display the **Image Settings** menu. The follow setup menu will appears.

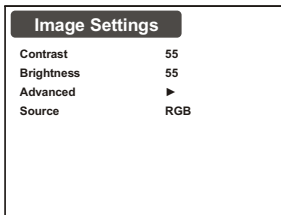

Select one of the options using ▲ or ▼.  
Adjust the chosen item using ▲ or ▼.

## Contrast, Brightness

Change the contrast, & brightness according to personal preference.

## Advanced Menu

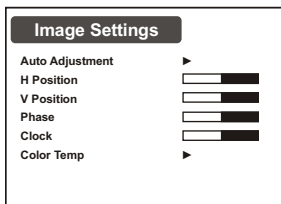

**H Position** is used to adjust the horizontal position of the image on the screen.

**V Position** is used to adjust the vertical position of the image on the screen.

**Phase** is Adjust the focus of screen's image.

**Clock** is Adjust the horizontal size of screen's image

**Color Temp** is used to control color temperature (6500K / 9300K)

## Source

Selects between the CVBS (Composite IN/OUTPUT) or S-Video (Super Video IN/OUTPUT), RGB (PC input) to be displayed

Press the MENU button to display the **Display Settings** menu. The follow setup menu will appears.

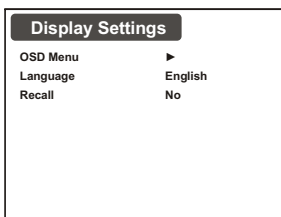

## OSD Menu

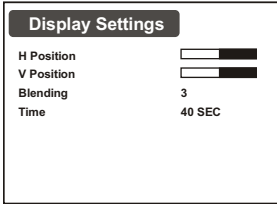

**H Position** is used to adjust the horizontal position of the Menu window on the screen.

**V Position** is used to adjust the vertical position of the Menu window on the screen.

**OSD Blending** is used to adjust the opaqueness of the background of the OSD.

**OSD Time** is used to adjust the OSD view time.

## Language

Change the OSD language according to personal preference

## Recall

Recall the monitor original factory setting

## ▣ CVBS( & S-Video) Mode

Press the MENU button to display the Image Settings menu. The following setup menu will appear.

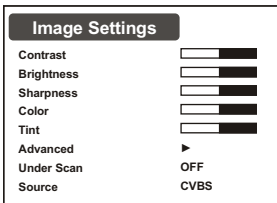

### Contrast, Brightness

Change the contrast, & brightness according to personal preference.

### Sharpness

sets the desired sharpening enhancement to the picture.

### Color

used to minutely adjust color.

### Tint

adjusts all the colors on the screen, but is most noticeable to the eye in reds and yellows, And is also usually set for pleasing face tones. (Appears in NTSC mode only).

## Advanced Menu

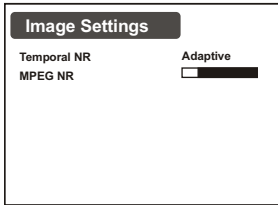

**Temporal NR** is the motion based noise reduction.

**MPEG NR** is for removing unwanted ringing and block noise from images that have undergone MPEG or JPEG compression and decompression.

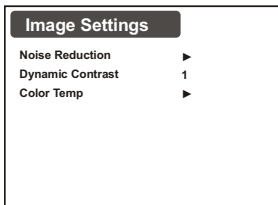

**Dynamic Contrast** is option to enhance the contrast of the image.

This feature makes the color much darker and brighter

**Color Temp** is used to control color temperature ( R / G / B )

## Under Scan

Adjusts the image size. ( Mode 1 / Mode 2 )

## Source

Selects between the CVBS ( Composite IN/OUTPUT) or S-Video ( Super Video IN/OUTPUT), RGB ( PC input) to be displayed

# CHAPTER 5 - SPECIFICATION

## 17.0" Color TFT-LCD Monitor

NO	ITEM		SPECIFICATION	
1	LCD	LCD Panel	17.0" TFT LCD Panel	
2		Active Display Area (Diagonal)	17.0 inches	
3		Pixel Format	1280(H) x 1024(V), RGB Vertical Stripe	
4		Pixel Pitch	0.264mm x 0.264mm	
5		Color Depths	8 Bit / 16.7M Colors	
6		Contrast Ratio	1000 : 1 (Typical)	
7		Brightness	300 cd/m2	
8		Viewing Angles (Left/Right/Up/Down)	80°/ 80°/ 80°/ 80°	
9		Light source / Lifetime	4CCFL / 50,000 Hours (Minimum)	
10		Response Time (Tr/Td)	5ms	
11	Video	Video Mode	NTSC/PAL (Auto Selection)	
12		Video Input Signal	Composite	1.0Vp-p, 75Ω
13			S-Video	0.7Vp-p(Luminance), 0.3Vp-p(Chrominance), 75Ω
14		Video Input Connector	Composite	BNC x 2
15			S-Video	4Pin Mini Din x 2
16		Termination	75Ω, Auto Termination	
17		Resolution	More than 540 Lines	
18	PC	Input Signal	Analog RGB (0.714Vp-p,75Ω), H&V Sync(TTL)	
19		Input Connector	15 pin D-sub	
20		Input Resolution	VGA 640 x 480 60~75Hz	
21			SVGA 800 x 600 56~75Hz	
22			XGA 1024 x 768 60~75Hz	
23			SXGA 1280 x 1024 60~75Hz	
24	Plug & Play	DDC 1/2B		
25	User Controls		Brightness, Contrast, Tint, Color, Sharpness, etc	
26	OSD Language		English / French / German / Italian / Spanish / Polish	
27	DC Power		12VDC ±5%	
28	Dimensions (W x H x D)	Net	382.5 x 416 x 301.5mm	
29		Packing	485 x 505 x 250mm	
30	Weight (Net/Packing)		5.3 / 7.45kg	
31	Operating Temperature		0 ~ 40 °C	
32	Case Material		Plastic	
33	Accessories		AC Adaptor, Power Cord, Manual	

## 19.0" Color TFT-LCD Monitor

NO	ITEM		SPECIFICATION	
1	LCD	LCD Panel	19.0" TFT LCD Panel	
2		Active Display Area (Diagonal)	19.0 inches	
3		Pixel Format	1280(H) x 1024(V), RGB Vertical Stripe	
4		Pixel Pitch	0.294mm x 0.294mm	
5		Color Depths	8 Bit / 16.7M Colors	
6		Contrast Ratio	1000 : 1 (Typical)	
7		Brightness	300 cd/m <sup>2</sup>	
8		Viewing Angles (Left/Right/Up/Down)	80°/ 80°/ 80°/ 80°	
9		Light source / Lifetime	4CCFL / 50,000 Hours (Minimum)	
10		Response Time (Tr/Td)	5ms	
11	Video	Video Mode	NTSC/PAL (Auto Selection)	
12		Video Input Signal	Composite	1.0Vp-p, 75Ω
13			S-Video	0.7Vp-p(Luminance), 0.3Vp-p(Chrominance), 75Ω
14		Video Input Connector	Composite	BNC x 2
15			S-Video	4Pin Mini Din x 2
16		Termination	75Ω, Auto Termination	
17		Resolution	More than 540 Lines	
18	PC	Input Signal	Analog RGB (0.714Vp-p,75Ω), H&V Sync(TTL)	
19		Input Connector	15 pin D-sub	
20		Input Resolution	VGA 640 x 480 60~75Hz	
21			SVGA 800 x 600 56~75Hz	
22			XGA 1024 x 768 60~75Hz	
23			SXGA 1280 x 1024 60~75Hz	
24		Plug & Play	DDC 1/2B	
25	User Controls		Brightness, Contrast, Tint, Color, Sharpness, etc	
26	OSD Language		English / French / German / Italian / Spanish / Polish	
27	DC Power		12VDC ±5%	
28	Dimensions (W x H x D)	Net	420 x 429 x 301.5mm	
29		Packing	520 x 517 x 250mm	
30	Weight (Net/Packing)		5.65 / 7.95Kg	
31	Operating Temperature		0 ~ 40 °C	
32	Case Material		Plastic	
33	Accessories		AC Adaptor, Power Cord, Manual	

## ▣ Dimensions

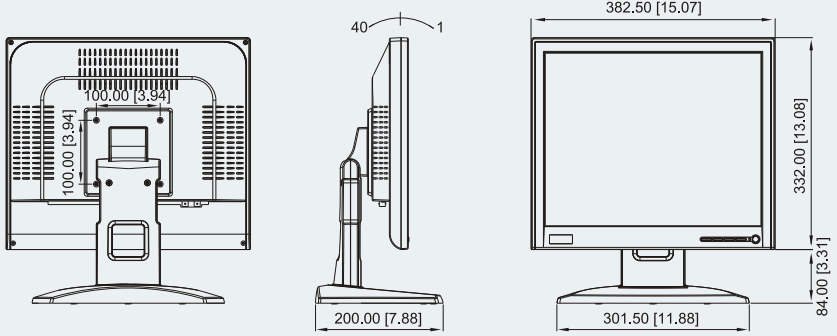

(17.0" Color TFT-LCD Monitor)

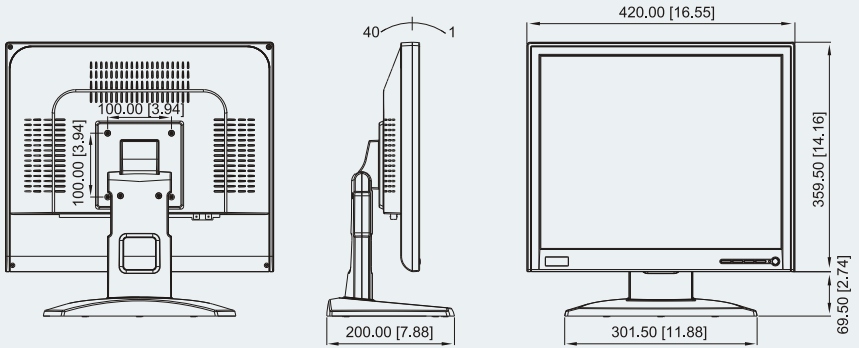

(19.0" Color TFT-LCD Monitor)



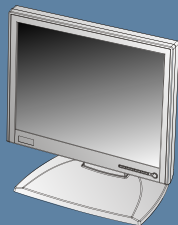
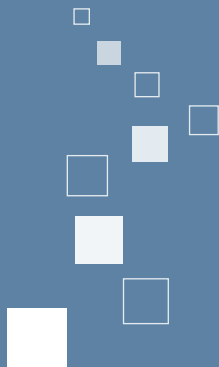

Instruction and Operation  
**M A N U A L**

## **COLOR TFT-LCD MONITOR**

PRINTED IN KOREA

50302261A